

DARRAN

BOSS

price list | effective January 2016 | updated 12.20.16



DATE	PAGE	MODIFICATION	DESCRIPTION
7.20.16	ALL	Removed finishes	Removed discontinued finishes SWS, STC and SGS

TABLE OF CONTENTS

Product index 2
 General Information 3
 Limited Lifetime Warranty 4
 Damages | Returns | Repairs 5
 Ordering Information 6
 Freight..... 7
 Features & Advantages 8
 Specifications..... 10
 Edges | Pulls | Knobs..... 11
 Grommets | Grommet Reference 12
 Modesty Reference | Grain Direction..... 13
 Drawer Dimensions | FILING Reference 14
 Conferencing Credenzas..... 15
 Boat Conference Tables 18
 Table Frames..... 21
 Options 22
 Power and Data..... 45

PRODUCT INDEX

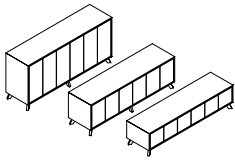

PAGE 15
CONFERCING CREDENZAS

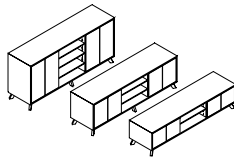

PAGE 16
CONFERCING CREDENZAS

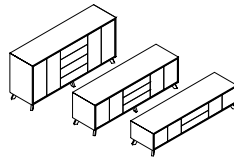

PAGE 17
CONFERCING CREDENZAS

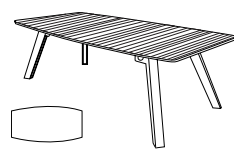

PAGE 18
BOAT CONFERENCE TABLES

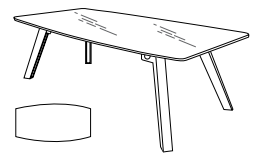

PAGE 19
BOAT CONFERENCE TABLES

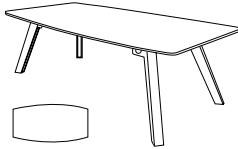

PAGE 20
BOAT CONFERENCE TABLES

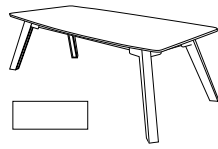

PAGE 21
TABLE FRAME



All DARRAN products are proudly manufactured in the U.S.A.

BUILT TO ORDER

Manufactured per order the way you want it, including modifications.

FULLY ASSEMBLED

Unless otherwise noted, all products are fully assembled and ready to use, including add-on options.

PERFORMANCE TESTED

All products are tested to ensure performance exceeds BIFMA / ANSI standards.



FINISH TECHNOLOGY

DARRAN has continued its partnership with AkzoNobel Chemicals (www.akzonobel.com) to develop a new finish technology further improving indoor air quality with a coating that meets today's environmental standards and supports LEED buildings.

ENVI-CT (Environmental Coatings Technology) utilizes advanced European finish technology to deliver a high-end furniture coating with superior performance in appearance and durability, allowing DARRAN to deliver more sustainable products to our customers.

ENVI-CT Advantages:

- › ENVI-CT is a re-engineered high performance Urethane Top Coat
- › Exceptional hardness and clarity
- › Highly resistant to solvents and chemicals
- › Plasticizer Migration resistant
- › Excellent UV inhibitors for maximum color resistance
- › Exceeds current and proposed future Federal and State air quality requirements
- › Field Repairable
- › Dynamic chamber emissions tested and certified compliant to ANSI/BIFMA X 7.1 Standard / LEED 4.5 Standard for low – VOC emitting furniture.
- › Standard with Anti-microbial additive.



ADVANTAGES

DARRAN has upgraded the standard Anti-microbial protection, to , the latest in Silver Ion Technology. DARRAN collaborated with the world's leader in finishing materials, to formulate an additive that will inhibit the growth of mold, mildew, fungus and bacteria on wood surfaces. This additive infuses Silver Ions into DARRAN's ENVI-CT (Environmental Urethane Finish Technology), creating a protective surface for the life of the furniture. The best part - is standard on all DARRAN Casegoods for no additional fee.

LIMITED LIFETIME WARRANTY

DARRAN Furniture Industries, Inc. ("DARRAN") warrants that each piece of furniture manufactured in its North Carolina Facilities will be free from defects in material and workmanship for as long as the original purchaser owns and uses the product. Subject to the limitations and exclusions herein, DARRAN, at its discretion and as the sole remedy under the DARRAN Limited Lifetime Warranty, will replace or repair a defective product or components with comparable product or components free of charge. This warranty is made only to the original purchaser from an authorized DARRAN dealer, for as long as that original purchaser owns and uses the product.

LIMITATIONS: USE / CARE

- › Warranty is limited to normal single shift use.
- › Warranty is limited to generally accepted care and maintenance of natural wood products and environments.
- › Natural wood surfaces are subject to denting, scratching, and gauging if not properly used and cared for. Warranty is subject to use and care in accordance with the use and care instructions provided in the Product Care section of this site (including, but not limited to, the care and maintenance guide downloads linked thereon), available at www.darran.com/product-care, which are incorporated herein by reference.

LIMITATIONS: MATERIALS / COMPONENTS

- › Laminates, Veneers / Finishes - 10 Years
- › Electrical lamps, Ballasts, Transformers - 5 Years
- › Fabrics, Pneumatic lifts, Foam - 5 Years
- › Custom products built to customers specifications - 3 Years

WARRANTY EXCLUSIONS

Damage identified as carrier or installer related.

- › Normal wear and tear of wood products during course of ownership.
- › Color, grain, or texture of natural wood materials, laminates, and other covering materials.
- › Damages or failures resulting from misuse, abuse, negligence, improper care, modifications, or relocation.
- › Non Commercial use or locations.
- › So-called "ghost" indentions and similar damage caused by the failure to use appropriate desk or writing pads.
- › Marble Tops applicable

All Warranty Claims are subject to DARRAN-approved inspections. Disputes may involve independent third-party evaluation

QUALITY ASSURANCE

DARRAN manufactures in accordance with the standards set by Architectural Woodwork Institute (AWI) for Quality Standards.

Every unit produced at DARRAN is completely inspected by an independent quality control team located within each plant whose emphasis is on assembly, finish, and final inspections with empowerment to stop any unit not meeting DARRAN's high quality standards.

LIGHT AND NATURAL FINISHES

The beauty of veneer and all wood products comes from the

variations created by nature including color, grain, and texture. These variations are not considered defects and DARRAN's Limited Lifetime Warranty does not cover color, grain and texture variations associated with natural wood and grain seen in any finish color. DARRAN sets standards for veneer selections; however, variations, especially apparent in light/natural finishes, will occur from one piece to another even if they are finished at the same time.

Finishes such as Clear Maple, Light/Gunstock Walnut, and Clear/Caramel Cherry will display more natural characteristics due to their light stain. Grain, pattern and color from unit to unit are not guaranteed or warranted and products will not be replaced due to these variations. Exposure to light and age will cause darkening of natural wood products; therefore DARRAN cannot guarantee or warrant finish match of new products being placed with existing products in the field.

GLASS

Use of glass overlays on surfaces will void DARRAN's Limited Lifetime Warranty, unless the overlay is installed and maintained in strict accordance with DARRAN's instructions. If an overlay is to be used, please contact DARRAN for installation and maintenance instructions.

GENERAL

Performance questions will be tested to generally accepted practices and AWI guidelines and standards for wood veneer furniture. To obtain performance of the Limited Lifetime Warranty, the purchaser should contact in writing the authorized DARRAN representatives or current dealer who sold the product to the purchaser or mail the warranty claim to:

Warranty Department

DARRAN Furniture Industries, Inc.

P.O. Box 7614

High Point, NC 27264

Telephone: 336-861-2400

Toll Free: 800-334-7891

email: warranty@darran.com

EXCEPT FOR THE LIMITED LIFETIME WARRANTY EXPRESSLY DESCRIBED HEREIN, DARRAN MAKES NO OTHER REPRESENTATION OR WARRANTY OF ANY KIND, EXPRESS OR IMPLIED. DARRAN MAKES NO WARRANTY OF MERCHANTABILITY OR FITNESS FOR A PARTICULAR PURPOSE, AND DARRAN WILL NOT UNDER ANY CIRCUMSTANCES BE LIABLE FOR ANY INCIDENTAL OR CONSEQUENTIAL DAMAGES, OR ANY INDIRECT OR SPECIAL DAMAGES.

THE WARRANTY AS STATED ABOVE, SUPERSEDES ALL PREVIOUS WARRANTIES

NO HASSLE FREIGHT DAMAGED MERCHANDISE

DARRAN products are packed in specially designed cartons and padding that protects all edges and corners from damage. This is proven by an industry low damage rate of .0030% per total pieces shipped.

For qualified freight damage claims DARRAN will take responsibility for the claim and remedy processes including assuming total cost coverage from claim settlements.

(Some items may not qualify. Contact Factory for specific details.)

QUALIFIED CLAIM CONDITIONS**VISIBLE CARTON DAMAGE**

1. Take digital pictures of the damaged carton and damaged furniture if visible damage is found upon delivery at the dock
2. Open all cartons with puncture or crushed corner damage.
3. Note any damage to the goods on the Carrier's freight bill as number of pieces damaged.

CONCEALED DAMAGE

1. Take digital pictures of the furniture as it sits partially unpacked. Also, photograph external and internal carton materials that correspond with the damaged area on the product.
2. Carton and damaged unit(s) must be located at the location matching the original delivery address for Carrier inspection.
3. Digital pictures must be provided of the damaged furniture and carton materials

For qualified claims per above contact DARRAN Customer Service Department at 1-800-334-7891 or complete DARRAN's online warranty report form within the 15 day limit. www.darran.com/warrantyreport

NON-QUALIFIED CLAIM CONDITIONS

1. Deliveries made to non-dock locations
2. Claims made after furniture is installed and/or removed from original delivery location
3. Carton and padding has been discarded
4. Carrier used was not DARRAN approved
5. Inspection reveals questionable damages

REPLACEMENT ORDERS

Replacement orders entered without replacement tagging or factory authorization is considered a new order without dispute, therefore full payment is expected and will be collected.

RETURN SHIPMENTS

DARRAN will not accept return of merchandise without a signed RA (return authorization) form.

DARRAN will specify the carrier to be used. Return bills of lading must be marked "Class 125" freight rate and a copy of the RA should be used as a packing list. All returns must be received by DARRAN within 30 days of the RA date or the products will be considered accepted by the customer.

All products being returned must be properly packed and protected to avoid freight damage. Whenever possible, use the original cartons in which the merchandise was shipped. Freight

damage, signs of usage, missing parts, etc., will result in an adjustment of any credit to be issued.

DARRAN will issue RA's for the following reasons:

1. Manufacturing defect (inspection required)
2. Order processing error by DARRAN
3. Shipping error
4. Mismatched carton / merchandise

SPECIFICATION CHANGES

We reserve the right to change without notice any dimension, style, or specification of any model in the DARRAN line. Dimensions shown in the price list are nominal. It is the buyer's responsibility to read specification carefully when matching existing goods is desired.

MANUFACTURING DEFECTS

Claims of manufacturing defects will not be entertained without prior consultation with DARRAN's warranty department. Unauthorized deduction in payment of invoices will not be allowed without prior factory approval. Unapproved deductions are subject to factor's late payment charges.

DAMAGE CLAIMS

Claims of manufacturing damage or freight damage reported as nicks, dents, scratches, etc. after installation of furniture will not be covered under warranty or freight claim.

ATTENTION: Damage claims involving glass or stone components must be inspected and damage noted on delivering freight bill to qualify for replacement.

REPAIR CHARGES

Factory authorization must be secured from DARRAN's warranty department prior to incurring repair charges. Warranty will utilize DARRAN's National Repair Service through the Furniture Medic Franchise (www.furnituremedic.com).

Repair charge authorizations are based on:

- › Set travel rate
- › Average regional job rate
- › Factory set maximum repair time
- › Falsely reported defect claims are subject to local service charges being charged to dealer/distributor.

FINISH MAINTENANCE

Wood office furniture and wood finishes can retain their natural beauty for life if proper care is taken and a stable environment is provided. Fluctuations in humidity and temperature cause panels and solid wood components to expand and contract and may lead to panel warpage and finish "checking" or cracking. Prolonged exposure of furniture to dry heat during winter months should be avoided. Careful examination of interior wood trim may indicate a damaging dry environment. If open joints, splits and cracks are appearing in trimwork consult with a HVAC professional for appropriate remedy.

DARRAN finishes are field repairable should damage occur. Professional furniture repair services are recommended. Regular cleaning with a non-silicone polish is recommended.

ORDERING

All orders should be emailed, mailed or transmitted by fax to:

DARRAN Furniture Industries, Inc.
P.O. Box 7614
High Point, NC 27264
email: orders@darran.com
Fax: 336-861-6485

DARRAN will only accept orders from authorized Dealers. All orders must be accurate and detailed. All Quick Ship orders must contain Quick Ship product ONLY. Orders should be separated and submitted according to lead time. Orders must contain Quick Ship code "QS" or have designated Quick Ship lead time to ensure correct order entry. Orders that contain multiple lead time products will be entered as one order and scheduled with the most extended lead time.

List product by office and tag accordingly. DARRAN will key alike all products under the office tag. Failure to assign and tag may result in random key number assignments. Keying is field changeable.

CREDIT APPROVAL

All orders are subject to credit approval for open account. All new accounts must be approved by a local DARRAN Sales Representative and should submit current financial information and trade references to:

DARRAN Furniture Industries, Inc. ATTN: Credit Department
P.O. Box 7614
High Point, NC 27264
Telephone: 336-861-2400 Toll Free: 800-334-7891
Fax: 336-861-2512

Orders submitted without accounts pre-approval or credit approval are subject to acceptance with lead times scheduled only after approval dates.

LEAD TIME SCHEDULE

DARRAN cannot assign a firm lead time until Credit approval and order accuracy are complete. Extended lead times due to credit or information delays are the responsibility of the Buyer.

ORDER DELAY / HOLD

Due to the committed manufacturing cost on Quick Ship processes, DARRAN cannot delay or hold orders, either in process or after completion.

CANCELLATION AND ORDER CHANGES - FEES

Acknowledged orders are considered firm orders and therefore not subject to cancellation or change. However, in the event we are able to stop an order prior to manufacturing process, we will consider cancellation or changes with a reprocessing fee of \$40.00 Net. Exceptions: Quickship orders cannot be changed or canceled after the 3rd business date after acknowledgment. Qualified changes/cancellations will be assessed a \$40.00 Net processing fee.

Changes or cancellation of order with special options or custom quoted items are also subject to additional material and vendor fee costs, plus a DARRAN special/custom reprocessing fee of \$100 NET.

ORDER MOVEUPS

Should an original scheduled ship date need to be improved, the Factory must be contacted 15 business days prior to the desired ship date. Move ups are subject to schedule availability.

ORDER ACKNOWLEDGMENT

Upon credit approval your order will be acknowledged and identified by an order number. When making reference to your order, please use this order number. Your acknowledgment is a detailed description of our interpretation of your order, pricing, shipping information, and estimated delivery date.

If you have not received an Acknowledgment within 10 Days of order issue, contact Customer Service immediately. All Quick Ship order acknowledgments will be faxed or emailed upon request to speed processing. Please read your acknowledgment carefully for correctness and notify DARRAN immediately of any discrepancies. Failure to notify relieves DARRAN from error liability.

Order acknowledgment is the final agreement between DARRAN and the customer superseding all previous communications regarding the order. DARRAN will not be responsible for errors made on orders placed by phone without written confirmation.

SELLING INFORMATION

Possession of this price list does not in itself constitute the right to sell DARRAN products. DARRAN products are sold and distributed through authorized dealerships. Contact factory for a listing of local representatives and dealerships.

INVOICE TERMS

Standard terms are NET 30 days. Finance charges of 1-1/2% will be added to delinquent accounts after 45 Days and for each 30 Days thereafter until paid.

Complaints involving newly received merchandise must be reported within 10 days from receipt to qualify for full invoice remittance suspension or term extension. Otherwise only items in dispute can be suspended from payment of invoice within terms.

WAREHOUSE/STORAGE

DARRAN will determine order warehousing approvals on a case by case basis. Orders that can be accommodated will be limited to a max of 30 days storage and must be invoiced at time of storage. Orders that exceed factory storage capacity will be transferred to local storage facilities subject to current storage rates and handling-transit charges. Storage charges must be paid prior to order release to shipping.

SHIPPING SCHEDULE

When requested, DARRAN will assist in locating special express carriers that may have short transit times. These services may exceed our prepaid freight costs; therefore, pricing is limited to the Freight Excluded formula with special express charges added to the invoice.

For special deliveries, DARRAN will make every effort to meet the appointed time; however DARRAN will not be responsible for any additional charges for late deliveries beyond our control.

PRICES

- › All prices shown are suggested list prices with freight included where indicated.
- › Freight allows delivery to one qualified destination.
- › Within the Continental USA, all orders above \$1,500 net are shipped FOB factory, freight prepaid and allowed. All orders less than \$1,500 net will be subject to a \$100 net freight charge.

SPECIAL HANDLING

- Orders requiring special services are subject to an additional charge. These services include:
- › Reconsignment from original destination to new destination - \$35 plus quoted rate to new destination
 - › Refused/Returned Freight: Freight refused at destination and returned to DARRAN - Charge will include freight charges by carrier
 - › Freight refused at time of delivery; returned to DARRAN to deliver at a later date - Charge will include freight charges by carrier
 - › Detention Fees (after 2 hours of waiting) - \$80 net
 - › Weekend delivery available Friday after 3:00 pm through Sunday night or Holiday - \$400 net
 - › Customer Pickup - No charge
 - › Change of Tags/Address/Phone #'s on Shipments - \$35 net

CALL BEFORE DELIVERY REQUEST

DARRAN will arrange for carriers to call before delivery when requested.

Important Non-Qualified Destinations DARRAN Prepaid Freight Pricing does not include delivery to:

- › Residential Areas
- › Restricted Commercial Areas
- › No Dock Locations
- › Inside delivery/setup service

Orders received and installed without professional Furniture Installers voids all Warranty Coverage.

CARRIER SELECTION

DARRAN selects and uses only carriers specialized in furniture transportation. Customer requested carriers can be authorized using Freight Excluded pricing with invoice add-on.

SPECIFIC DELIVERY TIMES

DARRAN will assist in coordinating a requested delivery time from a carrier. DARRAN makes no guarantees and accepts no responsibility for such services as DARRAN has no control over possible carrier hazards. To ensure specific time arrival, we recommend arranging single stop, designated load carriers. Less than trailer load (LTL) shipments cannot be coordinated for a guaranteed delivery time.

EXPRESS CARRIERS

When requested DARRAN will assist in locating special express carriers that may have short transit times. These services exceed our prepaid freight cost, therefore, pricing is limited to the Freight Excluded formula with special express charges added to invoice.

FEATURES & ADVANTAGES

VENEER TOPS

Wood veneer tops and high-pressure laminate tops feature a M2 Grade, CARB2 MDF Core with balanced 3-ply construction. Tops are 1-5/16" thick on all veneer and HPL products except for the Rift Collection, which features 1-1/2" thick primary work surfaces. Tops are connected to chassis with steel angle brackets, wood cleats and dowels. DARRAN only uses HPVA A Grade Flat Cut Cherry, Maple, and Walnut Veneers that are book-matched and slip-matched. Rift-Cut White Oak and Quarter-Cut Ash are available as premium veneers. DARRAN's Rift Collection features a double-cut veneer in a rift-cut pattern for a clean linear aesthetic. Veneer tops feature shapeable MDF edges, 3/4", 1", or 3mm external solid hardwood bands based on collection and edge selection. HPL tops feature a laminate self edge, shapeable MDF edge, or a 3mm solid wood edge based on edge selection.

CHASSIS & PEDESTAL CONSTRUCTION

All pedestals and chassis are constructed with 3/4" thick balanced 3-ply panels. Panels are securely fastened together using rails that are bored and doweled, glued, metal reinforcement brackets and wood cleat construction. Thick end panels are pre-bored to accept a tee nut for the adjustable glide and are reinforced with pvc banding to prevent glide tear out. Glue blocks are used where 3/4" thick panels are joined, bored for tee nut to accept adjustable glide.

ADJUSTABLE GLIDES

Glides provide 1" of vertical leveling adjustment. Glide bottom is durable metal.

DRAWERS

All drawers are constructed of four sides and a bottom, which are attached to a drawer front with screws for easy removal. Drawer fronts feature vertically matched veneer within each pedestal. 1/2" thick maple with dovetail joinery sides - 3/4" thick bottom.

SUSPENSIONS (PUSH TO OPEN)

All casegoods utilize cold rolled steel zinc plated high-grade drawer suspensions. All suspensions are warranted for the lifetime of the product. Box and File drawers are full extension, featuring steel ball bearings for a smoother quieter range of motion with soft close operation and are rated 100lbs. Lateral file drawers are a progressive action full extension suspension with the soft close operation and is rated at 150lbs. Lateral files include anti tip mechanism that will allow only one drawer at a time to be opened.

HINGES

Units with doors include 95 degree swing hinges.

WIRE MANAGEMENT

Boss Table legs are hollow allowing for integrated wire management. Wire(s) enter at the top of the leg and channel to the bottom of the leg at the floor for seamless wire management.

GROMMETS

Metal grommets are provided to match the drawer pull selection. Grommet is available in black, silver, white or antique brass. Must specify standard or non-standard location. Black plastic grommets are available as an option for vertical applications.

POWERPORTS

Choose from Byrne's Salt and Pepper power ports. Pepper includes one power plug and Salt includes two powered USB ports. Each leg can be fitted up to 2 ports. Choose one or combine 2 power ports per leg. Tables can have up to 8 power ports or any Salt and Pepper combination.

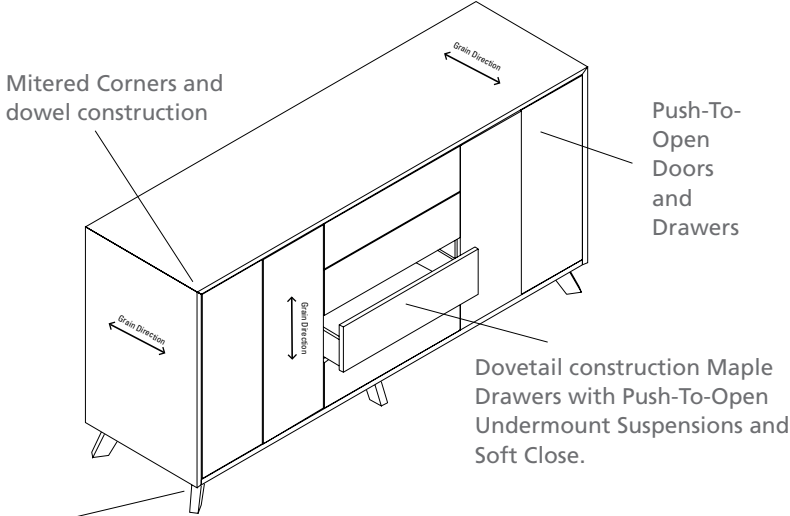

Walnut leg cover magnetized to a metal leg

1-1/2" Wood, 2cm Stone or 10 mm Back Painted Glass Tops are available.

Glass and Stone tops are supported with a 1-1/4" subtop

Magnetized Walnut aprons

Cover plates hide the wire management opening that are not in use and can be powder coated in white or black for no up-charge

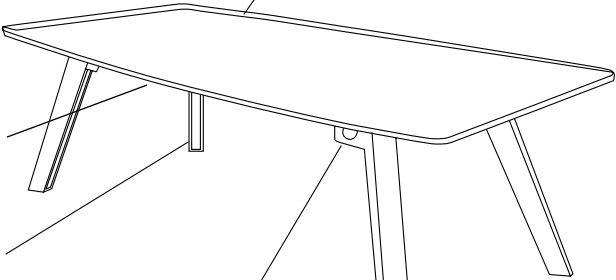

11 gauge steel metal frame, standard in White Finish

Legs are tubular steel with a cut out at the top and bottom for wire management

Power up with Byrne's Salt & Pepper Pods
Pepper: 1- Power Plug
Salt 2-USB Plus

7 Gauge metal legs covered with magnetized walnut caps

FINISHES

"W" VENEER

- WOW Clear Walnut
- WEW Executive Walnut
- WGW Gunstock Walnut
- WJW Judicial Walnut
- WNW Natural Walnut

"G" LAMINATE HPL TOPS

N/A

"M" THERMALLY FUSED LAMINATE

N/A

Boss Collection features Quartered Walnut Veneers

Send 3x3 or larger finish chip for color match. Custom finish upcharge is 3% or \$250 Net (whichever is greater).

FINISH

ENVI-CT Green Certified European Technology Coatings Finish with Anti-microbial protection.

CONFERENCE TOPS

1 1/2" thick core, Particleboard rated EPP/SCS/CARB-II material with 3 ply balanced construction. Quartered walnut veneers. Standard with hardwood rim bands.

CHASSIS

1" thick core, particleboard rated EPP/SCS/CARB-II material with 3 ply balanced construction. Pedestal and cabinets feature dowel construction reinforced with steel bracket plates, wood cleats, screws and glue. Exposed interiors feature finished veneer of same species as exterior faces.

NOTE: All units are standard with 1" adjustable glides that allow for leveling of units.

DOORS/DRAWER FRONTS

Door and drawer fronts are vertically matched in balanced sets. Quartered walnut.

STANDARD WOOD DRAWERS

Maple drawers are dobetailed at corners. Sides are 1/2" thick with a 3/4" thick bottom. UV cured finish

BOSS TABLE PROFILE

Boss Profile - Only Available on Table where option is shown
Hardwood Rim Band Species Same As Surface Veneer

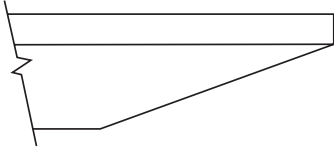

CREDENZA PROFILE

Flat Edge
Hardwood Rim Band Species Same As Surface Veneer

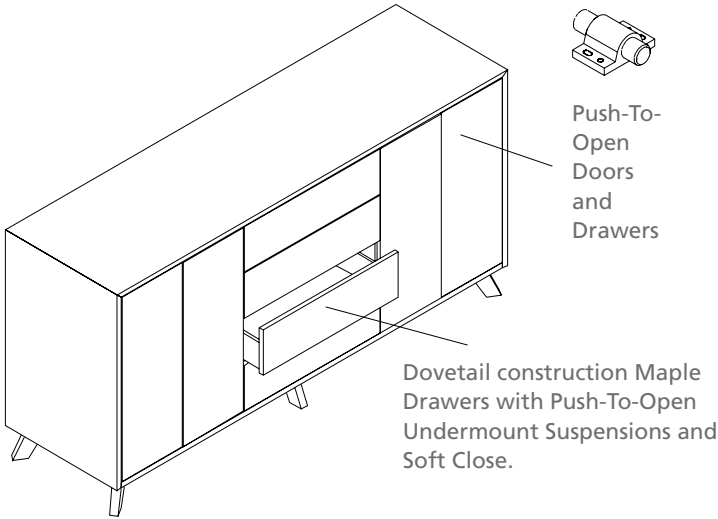
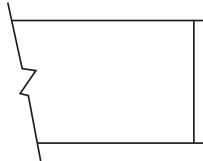

Push-To-Open
Doors
and
Drawers

Dovetail construction Maple
Drawers with Push-To-Open
Undermount Suspensions and
Soft Close.

OPTIONAL WIRE MANAGEMENT GROMMETS

Factory Installed

When grommets are specified or standard in a unit, DARRAN provides wire channels under the surface for organization and management of all communication wires and cords.

Grommets (Standard Location)

Specify Color and Left/Right/Center - \$45 ea.

- Black: TM30-R (Right), TM30-L (Left), TM30-C (Center)
- Silver: TM31-R (Right), TM31-L (Left), TM31-C (Center)
- Antique Brass: TM33-R (Right), TM33-L (Left), TM33-C (Center)

Grommets (Non-Standard Location)

Provide drawing w/ Grommet Location and Specify Color - \$90 ea.

- Black: TM30-NS
- Silver: TM31-NS
- Antique Brass: TM33-NS



GROMMETS (VERTICAL SURFACE)

Standard Location - \$45 ea.

- Black Plastic Vertical Surface: TM50-C (Bottom Center)

Non-Standard Location - \$90 ea.

- Black Plastic Vertical Surface: TM50-NS

GRAIN DIRECTION

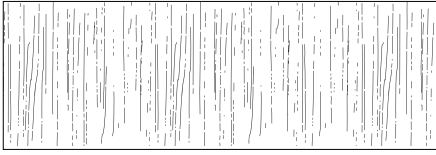

Credenza

INTERIOR DRAWER DIMENSIONS

UNIT DEPTH	DRAWER TYPE	OVERALL DIMENSIONS			INTERIOR DRAWER DIMENSIONS			NOTES
		W	D	H	W	D	H	
29" Wde	24" Box	27-7/8	18	5	26-7/8	17	3-3/4	Conference Box Drawers

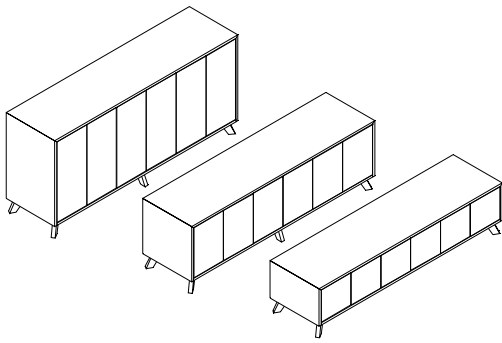

STORAGE WITH DOORS

STANDARD FEATURES

- 30" Height has 1 adjustable shelves per door section
- 42" Height has 2 adjustable shelves per door section
- Floor levelers (adjustable 1/2")
- Open Plan
- Quartered Walnut runs horizontally on case and vertically on doors. Top is short grain.

NOTES

- Boss features push-to-open drawers and doors. Hardware is not available.
- Center vertical section will be removed when REF-01 option is specified. For interior cabinet dimensions contact factory

[CLICK HERE TO VIEW PRODUCT INDEX](#)

1 SELECT A STYLE

DIMENSIONS		STYLE NUMBER	LIST PRICE	STYLE NUMBER	LIST PRICE	STYLE NUMBER	LIST PRICE
W" x D" x H"	WGT	"W" Veneer Top Veneer Chassis		"G" HPL High Pressure Laminate Top Veneer Chassis		"M" TFL Thermally Fused Laminate Top Thermally Fused Laminate Chassis	
90" 6 Door Storage Credenza							
90 x 24 x 42	490	BOS9042CA125W	6125	"G" Style N/A		"M" Style N/A	
90 x 24 x 30	330	BOS9030CA125W	5350	"G" Style N/A		"M" Style N/A	
90 x 24 x 22	220	BOS9022CA125W	4850	"G" Style N/A		"M" Style N/A	
84" 6 Door Storage Credenza							
84 x 24 x 42	460	BOS8442CA125W	5740	"G" Style N/A		"M" Style N/A	
84 x 24 x 30	310	BOS8430CA125W	5015	"G" Style N/A		"M" Style N/A	
84 x 24 x 22	205	BOS8422CA125W	4545	"G" Style N/A		"M" Style N/A	
72" 4 Door Storage Credenza							
72 x 24 x 42	395	BOS7242CA125W	4960	"G" Style N/A		"M" Style N/A	
72 x 24 x 30	265	BOS7230CA125W	4355	"G" Style N/A		"M" Style N/A	
72 x 24 x 22	180	BOS7222CA125W	3930	"G" Style N/A		"M" Style N/A	

2 SELECT A FINISH

"W" Veneer	"G" HPL	"M" TFL	
WEW	-	-	Executive Walnut
WGW	-	-	Gunstock Walnut
WJW	-	-	Judicial Walnut
WNW	-	-	Natural Walnut
WOW	-	-	Clear Walnut

3 SELECT AN EDGE

Edge Profile
Option Not Available

5 OPTIONS

- DOOR**
- D2: Wood Door Lock - \$95 per Door Set
 - D6: Delete Doors - n/c
 - WPD3061: Designer White Painted Fronts - \$125 per 2 door section
- REFRIGERATOR**
- REF-01: Specify Right or Left Refrigerator option (Water mat, heat vent and grommet hole) - \$195
 - Option is available on BOS9042CA125, BOS8442CA125, BOS7224CA125
- TRASH CAN**
- Specify Location
- TRC230: Trash Can Insert - (2) 30 gal containers - \$475
 - Option is available on BOS9042CA125, BOS8442CA125, BOS7224CA125

4 SELECT HARDWARE

Hardware
Option Not Available

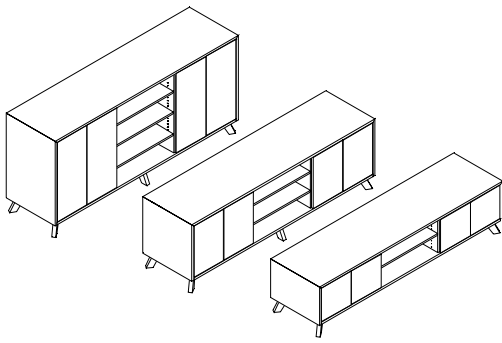

STORAGE WITH DOORS/ OPEN CENTER

STANDARD FEATURES

- 30" Height has 1 adjustable shelves per door section
- 42" Height has 2 adjustable shelves per door section
- Floor levelers (adjustable 1/2")
- Open Plan
- Quartered Walnut runs horizontally on case and vertically on doors. Top is short grain.

NOTES

- Boss features push-to-open drawers and doors. Hardware is not available.
- Center vertical section will be removed when REF-01 option is specified. For interior cabinet dimensions contact factory

[CLICK HERE TO VIEW PRODUCT INDEX](#)

1 SELECT A STYLE

DIMENSIONS		STYLE NUMBER	LIST PRICE	STYLE NUMBER	LIST PRICE	STYLE NUMBER	LIST PRICE
W" x D" x H"	WGT	"W" Veneer Top Veneer Chassis		"G" HPL High Pressure Laminate Top Veneer Chassis		"M" TFL Thermally Fused Laminate Top Thermally Fused Laminate Chassis	
90" 4 Door Open/Storage Credenza							
90 x 24 x 42	470	BOS9042CA128W	5925	"G" Style N/A		"M" Style N/A	
90 x 24 x 30	310	BOS9030CA128W	5200	"G" Style N/A		"M" Style N/A	
90 x 24 x 22	200	BOS9022CA128W	4750	"G" Style N/A		"M" Style N/A	
84" 4 Door Open/Storage Credenza							
84 x 24 x 42	440	BOS8442CA128W	5555	"G" Style N/A		"M" Style N/A	
84 x 24 x 30	290	BOS8430CA128W	4875	"G" Style N/A		"M" Style N/A	
84 x 24 x 22	185	BOS8422CA128W	4450	"G" Style N/A		"M" Style N/A	
72" 2 Door Open/Storage Credenza							
72 x 24 x 42	375	BOS7242CA128W	4800	"G" Style N/A		"M" Style N/A	
72 x 24 x 30	245	BOS7230CA128W	4215	"G" Style N/A		"M" Style N/A	
72 x 24 x 22	160	BOS7222CA128W	3850	"G" Style N/A		"M" Style N/A	

2 SELECT A FINISH

"W" Veneer	"G" HPL	"M" TFL	
WEW	-	-	Executive Walnut
WGW	-	-	Gunstock Walnut
WJW	-	-	Judicial Walnut
WNW	-	-	Natural Walnut
WOW	-	-	Clear Walnut

3 SELECT AN EDGE

Edge Profile
Option Not Available

5 OPTIONS

- DOOR**
- D2: Wood Door Lock - \$95 per Door Set
 - D6: Delete Doors - n/c
 - WPD3061: Designer White Painted Fronts - \$125 per 2 door section
- REFRIGERATOR**
- REF-01: Specify Right or Left Refrigerator option (Water mat, heat vent and grommet hole) - \$195
 - Option is available on BOS9042CA128, BOS8442CA128, BOS7224CA128
- TRASH CAN**
- Specify Location
- TRC230: Trash Can Insert - (2) 30 gal containers - \$475
 - Option is available on BOS9042CA128, BOS8442CA128, BOS7224CA128

4 SELECT HARDWARE

Hardware
Option Not Available

CONFERENCE CREDENZAS

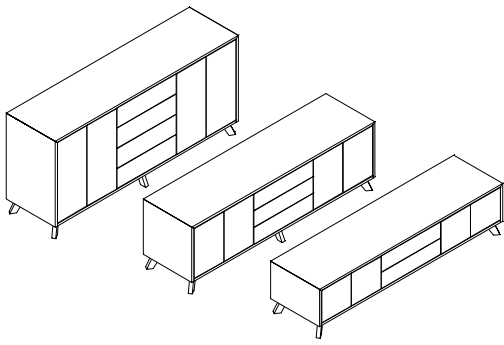

BOX DRAWERS/STORAGE WITH DOORS

STANDARD FEATURES

- 30" Height has 1 adjustable shelves per door section
- 42" Height has 2 adjustable shelves per door section
- Drawers feature soft close suspension
- Floor levelers (adjustable 1/2")
- Open Plan
- Quartered Walnut runs horizontally on case and vertically on doors. Top is short grain.

NOTES

- Boss features push-to-open drawers and doors. Hardware is not available.
- Center vertical section will be removed when REF-01 option is specified. For interior cabinet dimensions contact factory

[CLICK HERE TO VIEW PRODUCT INDEX](#)

1 SELECT A STYLE

DIMENSIONS		STYLE NUMBER	LIST PRICE	STYLE NUMBER	LIST PRICE	STYLE NUMBER	LIST PRICE
W" x D" x H"	WGT	"W" Veneer Top Veneer Chassis		"G" HPL High Pressure Laminate Top Veneer Chassis		"M" TFL Thermally Fused Laminate Top Thermally Fused Laminate Chassis	
90" 4 Door/Drawer Storage Credenza							
90 x 24 x 42	490	BOS9042CA139W	7425	"G" Style N/A		"M" Style N/A	
90 x 24 x 30	330	BOS9030CA139W	6230	"G" Style N/A		"M" Style N/A	
90 x 24 x 22	220	BOS9022CA139W	5505	"G" Style N/A		"M" Style N/A	
84" 4 Door/4 Drawer Storage Credenza							
84 x 24 x 42	460	BOS8442CA139W	7030	"G" Style N/A		"M" Style N/A	
84 x 24 x 30	310	BOS8430CA139W	5890	"G" Style N/A		"M" Style N/A	
84 x 24 x 22	205	BOS8422CA139W	5195	"G" Style N/A		"M" Style N/A	
72" 2 Door/ Drawer Storage Credenza							
72 x 24 x 42	395	BOS7242CA139W	6225	"G" Style N/A		"M" Style N/A	
72 x 24 x 30	265	BOS7230CA139W	5205	"G" Style N/A		"M" Style N/A	
72 x 24 x 22	180	BOS7222CA139W	4565	"G" Style N/A		"M" Style N/A	

2 SELECT A FINISH

"W" Veneer	"G" HPL	"M" TFL	
WEW	-	-	Executive Walnut
WGW	-	-	Gunstock Walnut
WJW	-	-	Judicial Walnut
WNW	-	-	Natural Walnut
WOW	-	-	Clear Walnut

3 SELECT AN EDGE

Edge Profile
Option Not Available

5 OPTIONS

- DOOR**
- D2: Wood Door Lock - \$95 per Door Set
 - D6: Delete Doors - n/c
 - WPD3061: Designer White Painted Fronts - \$125 per 2 door section
 - WPD3062: Designer White Painted Fronts - \$60 per drawer
- REFRIGERATOR**
- REF-01: Specify Right or Left Refrigerator option (Water mat, heat vent and grommet hole) - \$195
 - Option is available on BOS9042CA139, BOS8442CA139, BOS7224CA139
- TRASH CAN**
- Specify Location
- TRC230: Trash Can Insert - (2) 30 gal containers - \$475
 - Option is available on BOS9042CA139, BOS8442CA139, BOS7224CA139

4 SELECT HARDWARE

Hardware
Option Not Available

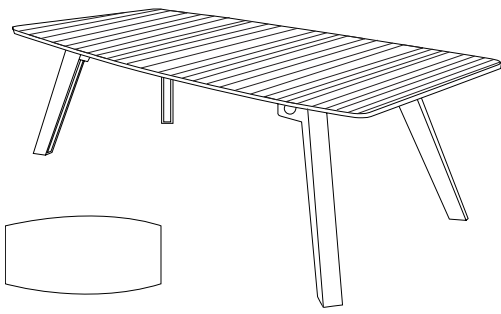

QUARTERED WALNUT TOP

STANDARD FEATURES

- 1.5" thick Quartered Walnut Top
- Adjustable Glides
- Hidden Wire Management down each leg, specify legs to be powered
- Quartered Walnut Runs Short Grain
- Steel Frame with magnetized solid wood aprons and leg caps
- Tops and bases are pre-located to ensure proper installation location

NOTES

- Table Ships KD

[CLICK HERE TO VIEW PRODUCT INDEX](#)

1 SELECT A STYLE

DIMENSIONS		STYLE NUMBER	LIST PRICE	STYLE NUMBER	LIST PRICE	STYLE NUMBER	LIST PRICE
W" x D" x H"	WGT	"W" Veneer Veneer Top Veneer Chassis		"G" HPL High Pressure Laminate Top Veneer Chassis		"M" TFL Thermally Fused Laminate Top Thermally Fused Laminate Chassis	
72 x 42 x 30	240	BOS7242WT200W	4800	"G" Option N/A		"M" Option N/A	
84 x 42 x 30	280	BOS8442WT200W	5235	"G" Option N/A		"M" Option N/A	
96 x 48 x 30	315	BOS9648WT200W	5530	"G" Option N/A		"M" Option N/A	

2 SELECT A FINISH

"W" Veneer	"G" HPL	"M" TFL	
WEW	-	-	Executive Walnut
GWG	-	-	Gunstock Walnut
WJW	-	-	Judicial Walnut
WNW	-	-	Natural Walnut
WOW	-	-	Clear Walnut

3 SELECT AN EDGE



5 OPTIONS

POWER

- PDP01: Pepper (Power) - \$95 ea.
- PDS01: Salt (Powered USB) - \$225 ea.
- PD717: Power Supply Cordset - \$95 ea.
- Can specify up to 8 total power units (Specify location on drawing)
- W1: Horizontal J-Channel Wire Management Raceway - \$75 per 4'

4 SELECT HARDWARE

Hardware Option Not Available

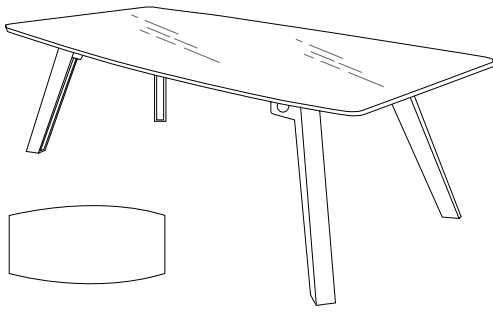

10MM ICE WHITE GLASS TOP

STANDARD FEATURES

- 10mm Ice White Glass Top
- 1-1/4" Subtop
- Adjustable glides
- Hidden Wire Management down each leg, specify legs to be powered
- Steel Frame with magnetized solid wood aprons and leg caps

NOTES

- Table Ships KD

[CLICK HERE TO VIEW PRODUCT INDEX](#)

1 SELECT A STYLE

DIMENSIONS		STYLE NUMBER	LIST PRICE	STYLE NUMBER	LIST PRICE	STYLE NUMBER	LIST PRICE
W" x D" x H"	WGT	"W" Veneer Glass Top Veneer Base		"G" HPL High Pressure Laminate Top Veneer Chassis		"M" TFL Thermally Fused Laminate Top Thermally Fused Laminate Chassis	
72 x 42 x 30	300	BOS7242GT200W	8620	"G" Option N/A		"M" Option N/A	
84 x 42 x 30	350	BOS8442GT200W	9625	"G" Option N/A		"M" Option N/A	
96 x 48 x 30	560	BOS9648GT200W	10670	"G" Option N/A		"M" Option N/A	

2 SELECT A FINISH

"W" Veneer	"G" HPL	"M" TFL	
WEW	-	-	Executive Walnut
GWG	-	-	Gunstock Walnut
WJW	-	-	Judicial Walnut
WNW	-	-	Natural Walnut
WOW	-	-	Clear Walnut

3 SELECT AN EDGE



5 OPTIONS

- POWER**
- PDP01: Pepper (Power) - \$95 ea.
 - PDS01: Salt (Powered USB) - \$225 ea.
 - PD717: Power Supply Cordset - \$95 ea.
 - Can specify up to 8 total power units (Specify location on drawing)
 - W1: Horizontal J-Channel Wire Management Raceway - \$75 per 4'

4 SELECT HARDWARE

Hardware
Option Not
Available

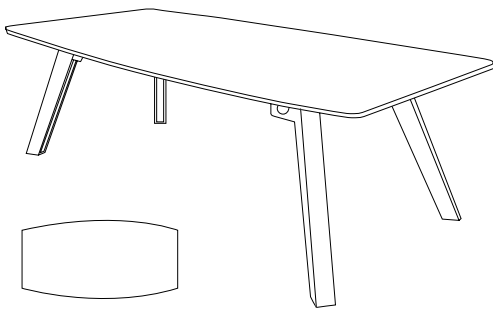

2CM WHITE CARRARA TOP TABLE

STANDARD FEATURES

- 1-1/4" Subtop
- 2cm White Carrara Top Table
- Adjustable glides
- Hidden Wire Management down each leg, specify legs to be powered
- Steel Frame with magnetized solid wood aprons and leg caps

NOTES

- Table Ships KD

[CLICK HERE TO VIEW PRODUCT INDEX](#)

1 SELECT A STYLE

DIMENSIONS		STYLE NUMBER	LIST PRICE	STYLE NUMBER	LIST PRICE	STYLE NUMBER	LIST PRICE
W" x D" x H"	WGT	"W" Veneer Stone Top Veneer Base		"G" HPL High Pressure Laminate Top Veneer Chassis		"M" TFL Thermally Fused Laminate Top Thermally Fused Laminate Chassis	
72 x 42 x 30	555	BOS7242ST200W	9975	"G" Option N/A		"M" Option N/A	
84 x 42 x 30	632	BOS8442ST200W	11545	"G" Option N/A		"M" Option N/A	
96 x 48 x 30	800	BOS9648ST200W	13350	"G" Option N/A		"M" Option N/A	

2 SELECT A FINISH

"W" Veneer	"G" HPL	"M" TFL	
WEW	-	-	Executive Walnut
GWG	-	-	Gunstock Walnut
WJW	-	-	Judicial Walnut
WNW	-	-	Natural Walnut
WOW	-	-	Clear Walnut

3 SELECT AN EDGE



5 OPTIONS

- POWER**
- PDP01: Pepper (Power) - \$95 ea.
 - PDS01: Salt (Powered USB) - \$225 ea.
 - PD717: Power Supply Cordset - \$95 ea.
 - Can specify up to 8 total power units (Specify location on drawing)
 - W1: Horizontal J-Channel Wire Management Raceway - \$75 per 4'

4 SELECT HARDWARE

Hardware Option Not Available

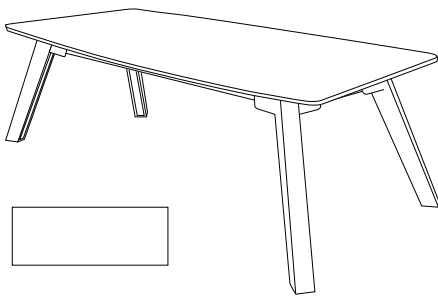

TABLE FRAME W/ WOOD APRONS, LEGS & SUBTOP

STANDARD FEATURES

- Adjustable glides
- Edge of subtop matches leg finish
- Hidden Wire Management down each leg, specify legs to be powered
- Steel Frame with magnetized solid wood aprons and leg caps
- Top & Bottom of Subtop is Finished Black (Template is available upon request for customers own top material)

NOTES

- Frame Ships KD

[CLICK HERE TO VIEW PRODUCT INDEX](#)

1 SELECT A STYLE

DIMENSIONS		STYLE NUMBER	LIST PRICE	STYLE NUMBER	LIST PRICE	STYLE NUMBER	LIST PRICE
W" x D" x H"	WGT	"W" Veneer Top Veneer Chassis		"G" HPL High Pressure Laminate Top Veneer Chassis		"M" TFL Thermally Fused Laminate Top	
72 x 42 x 29	140	BOS7242FO199W	4565	"G" Option N/A		"M" Option N/A	
84 x 42 x 29	165	BOS8442FO199W	4840	"G" Option N/A		"M" Option N/A	
96 x 48 x 29	220	BOS9648FO199W	5130	"G" Option N/A		"M" Option N/A	

2 SELECT A FINISH

"W" Veneer	"G" HPL	"M" TFL	
WEW	-	-	Executive Walnut
GWG	-	-	Gunstock Walnut
WJW	-	-	Judicial Walnut
WNW	-	-	Natural Walnut
WOW	-	-	Clear Walnut

3 SELECT AN EDGE



5 OPTIONS

- POWER**
- PDP01: Pepper (Power) - \$95 ea.
 - PDS01: Salt (Powered USB) - \$225 ea.
 - PD717: Power Supply Cordset - \$95 ea.
 - Can specify up to 8 total power units (Specify location on drawing)
 - W1: Horizontal J-Channel Wire Management Raceway - \$75 per 4'

4 SELECT HARDWARE

Hardware Option Not Available

BASE MODIFICATIONS

RUNOFF SLEIGH BASE

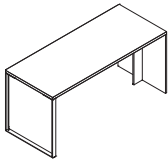

STYLE NUMBER	LIST PRICE	SPECIFICATIONS
24" Metal Sleigh Base SSB24	450	- Metal Sleigh base - standard in silver finish
30" Metal Sleigh Base SSB30	475	
36" Metal Sleigh Base SSB36	495	

Available: - Central, NOT SO square, Spaces

COMPUTER SUPPORT

DELUXE SINGLE MONITOR ARM W/ USB POST



STYLE NUMBER	LIST PRICE	SPECIFICATIONS
MA1952	495	<ul style="list-style-type: none"> - (4) 2.0 USB Ports - Post Length: 22-1/2"H, Post Base Requires 80mm Dia. Hole - Spring Assist - Full Movement Arm, Arm Extends Up To 13 - 3/8" - Supports Screens Up To 24", Swivels 180 degrees - Mount Plate Tilts 85 degrees - Arm: Die Cast Aluminum <p>Notes</p> <ul style="list-style-type: none"> - Surface Factory Bored / Ready To Install

Available: - All DARRAN Collections

COMPUTER SUPPORT

DELUXE DOUBLE MONITOR ARM W/ USB POST



STYLE NUMBER	LIST PRICE	SPECIFICATIONS
MA2952	795	<ul style="list-style-type: none"> - (4) 2.0 USB Ports - Post Length: 22-1/2"H, Post Base Requires 80mm Dia. Hole - Spring Assist - Full Movement Arm, Arm Extends Up To 13 - 3/8" - Supports Screens Up To 24", Swivels 180 degrees - Mount Plate Tilts 85 degrees - Arm: Die Cast Aluminum <p>Notes</p> <ul style="list-style-type: none"> - Surface Factory Bored / Ready To Install - Can Accommodate Up To 4 Monitors By Ordering Extra Double Arms. 1 Extra Arm and 1 Double Clamp - Add\$305

Available: - All DARRAN Collections

COMPUTER SUPPORT

CPU RETRACTABLE CRADLE

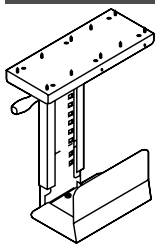

STYLE NUMBER	LIST PRICE	SPECIFICATIONS
K18	195	<ul style="list-style-type: none"> - Black Metal CPU Carriage - Full 360° swivel capability allows easy access to rear of CPU for cables / wires - Track allows 8- 1/2" extension - Width Adjustment 5-1/2" to 9-1/4" - Height adjustment 14- 5/8" to 20- 1/2" - Black epoxy finish <p>Notes</p> <ul style="list-style-type: none"> - Factory Installed

Available: - All DARRAN Collections

COMPUTER SUPPORT

ARTICULATING KEYBOARD TRAY

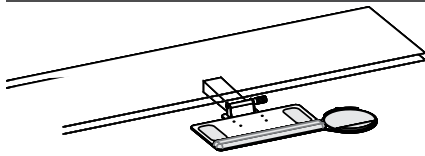

STYLE NUMBER

Factory Installed

K28

Field Installed

K28F

LIST PRICE

375

395

SPECIFICATIONS

- Adjusts effortlessly - A simple one-handed motion allows the keyboard to be repositioned instantly, without the use of locks or levers
- Encourages low-risk postures - Maximizes adjustability within a safe operating range.
- Will last a lifetime - Exceeds all applicable BIFMA Standards and comes with a lifetime guarantee.

Notes

- Factory Installed (standard)
- FIELD INSTALL - \$395

Available: - All DARRAN Collections

COMPUTER SUPPORT

TRADITIONAL PULL-OUT DRAWER WITH KEYBOARD TRAY

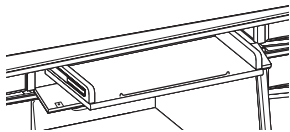

STYLE NUMBER

K21

LIST PRICE

450

SPECIFICATIONS

- Traditional Pull-out Drawer w/Keyboard Tray

Available: - Jamestown

CONFERENCE DESK SUPPORT POST OPTIONS

WOOD DRUM



STYLE NUMBER

6" Diameter Drum

B6

LIST PRICE

395

SPECIFICATIONS

- Available in Walnut / Cherry / Maple
- Adjustable levelers
- Replaces standard metal round legs

Notes

- Specify Finish

Available: - Central Park, NOT SO square

CONFERENCE DESK SUPPORT POST OPTIONS

WOOD HALF DRUM

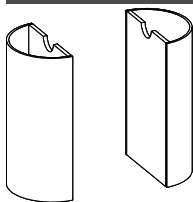

STYLE NUMBER

8" Half Drum

HC08

16" Diameter Drum

HC16

LIST PRICE

695

895

SPECIFICATIONS

- Available in Walnut / Cherry / Maple
- Adjustable levelers

Notes

- Specify Finish

Available: - Central Park, NOT SO square, Richmond Park

CONFERENCE DESK SUPPORT POST OPTIONS

METAL OVAL "T" BASE



STYLE NUMBER

Silver

32MOTS

Black

32MOTB

LIST PRICE

595

595

SPECIFICATIONS

- 3" x 1" Aluminum square extrusion
- Leveler adjustment
- Oval Post

Available: - Silver or Black

DOOR MODIFICATIONS

SOFT CLOSE DOOR HINGE



STYLE NUMBER

D9SC

LIST PRICE

15 Per Door

SPECIFICATIONS

- Snap onto standard door hinge
- Requires (1) per door
- Max door height 43"
- Factory installed where specified
- Individually shipped for field installation

Notes

- Specify Each Item To Have Slow Close Feature

Available: - All DARRAN Collections

DOOR MODIFICATIONS

DELETE DOORS

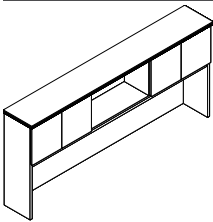

STYLE NUMBER

D6

LIST PRICE

N/C

SPECIFICATIONS

- Standard Door overheads and cabinets can have door deleted for open access. Modification of hinge rails and structural components are made face ready.

Available: - All DARRAN Collections

DOOR MODIFICATIONS

- REPLACE GLASS PANEL INSERT WITH VENEER PANEL INSERT



Glass Door

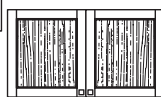

Wood Door

STYLE NUMBER

D35

LIST PRICE

30 per door

SPECIFICATIONS

- Replace glass panel insert with veneer panel insert

Notes

- Not Available on "M" skus
- Glass door has beveled glass
- Wood door w/ veneer insert - only available on "W" style

Available: - Capitol Park, Jamestown, Prado, Richmond Park

DOOR MODIFICATIONS

DELETE DOORS/REPLACE BLACK LAMINATE SHELF W/ FINISHED SHELF

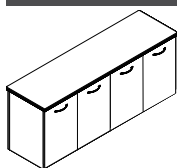

STYLE NUMBER
D6A

LIST PRICE
N/C

SPECIFICATIONS
- Delete doors and replace black laminate shelf with finished shelf

Available: - All Storage Credenzas ("W"/"G" Styles).
Excludes Rail.

DOOR MODIFICATIONS

PANEL DOOR LOCK

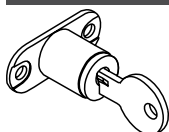

STYLE NUMBER
D2

LIST PRICE
95 Per Door Set

SPECIFICATIONS
- Door Locks - 1 Door w/ Lock, Other Door w/ Catch Latch
- Contact Customer Service regarding limited lock locations and keying.

Available: - Panel Doors, Wood Frame Doors, and Silverluma doors

DOOR MODIFICATIONS

GLASS DOOR LOCK

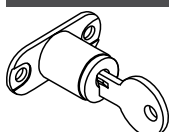

STYLE NUMBER
D2-G

LIST PRICE
195 Per Door Set

SPECIFICATIONS
- Door Locks - 1 Door w/ Lock, Other Door w/ Catch Latch
- Contact Customer Service regarding limited lock locations and keying.

Available: - Glass Doors

DOOR MODIFICATIONS

BOX DRAWER ACCESSORIES

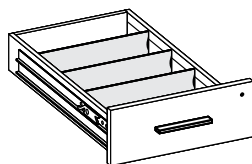

STYLE NUMBER
Wood Drawer Dividers w/ Clips
K-DIV
Single Tray - Utility Tray
K-Sut

LIST PRICE
SET OF 3 - 30
30 each

SPECIFICATIONS
- K-DIV Extra Wood Drawer Dividers with Clips, Top Box drawers standard with 1 divider
- K-SUT Single Tray - Utility Tray, Specify Legal or Letter drawer width

Available: - All DARRAN Collections. Excludes Rail.

DRAWER OPTIONS

TRADITIONAL CENTER DRAWER

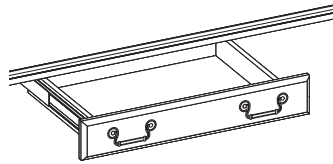

STYLE NUMBER
K17
Add Skirt Option
K17-SK

LIST PRICE
225

325

SPECIFICATIONS
- Standard on desks in Jamestown Collection. Optional center drawers available for bullet conference desk, kneespace credenzas and corner units. 3 ply hardwood drawer / dowel construction profile shaped drawer front. Specify pull choice.

Available: - Jamestown

DRAWER OPTIONS

FINISHED TRADITIONAL CENTER DRAWER

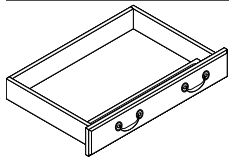

STYLE NUMBER
K30
Add Skirt Option
K30-SK

LIST PRICE
195

295

SPECIFICATIONS
- Veneer drawer front finished to match unit veneer. Edges are scalloped to match standard drawers.
- Standard with matching wood grain pencil tray
- Pulls selected to match unit installed

Available: - Richmond Park

DRAWER OPTIONS

FINISHED CENTER DRAWER

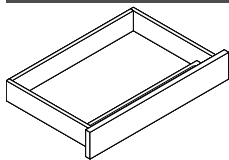

STYLE NUMBER
K31
Add Skirt Option
K31-SK

LIST PRICE
195

295

SPECIFICATIONS
- Veneer drawer front finished to match unit W or G style veneer.
- Ball bearing smooth operation
- Drawer has lifetime guarantee
- Standard with matching wood grain pencil tray
- Laminate drawer front to match laminate unit (M style)

Available: - Central Park, NOT SO square, Rail

DRAWER OPTIONS

PRADO/SPACES CENTER DRAWER - VENEER BOTTOM

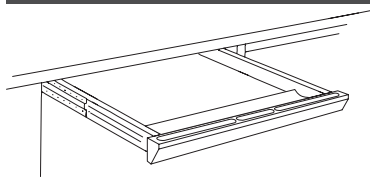

STYLE NUMBER
Factory Installed
K1
Field Installed
K1BVF

LIST PRICE
275

275

SPECIFICATIONS
- Solid hardwood front beveled and rounded with recessed pencil tray.

Available: - Prado, Spaces

DRAWER OPTIONS

CENTER DRAWER

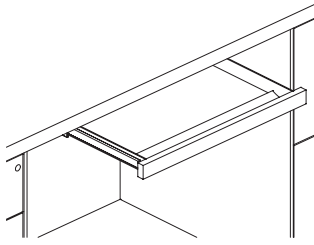

STYLE NUMBER

LIST PRICE

SPECIFICATIONS

Factory Installed

- Center Drawer - Factory Installed, Center Drawer - Field Installed

K1R

275

Field Installed

K1RF

275

Available: - Rift

DRAWER OPTIONS

CENTER DRAWER WITH SKIRT

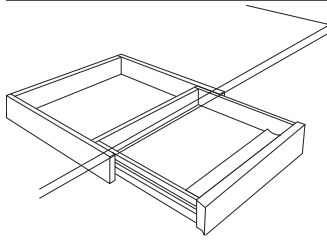

STYLE NUMBER

LIST PRICE

SPECIFICATIONS

Factory Installed

- Center Drawer - Factory Installed, Center Drawer - Field Installed

K2R

375

Field Installed

K2RF

375

Add Skirt Option

K2R-SK

475

Available: - Rift

DRAWER OPTIONS - BOTTOM COVER

BLACK DURA-LEATHER DRAWER BOTTOM COVERS

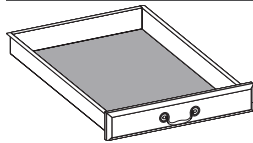

STYLE NUMBER

LIST PRICE

SPECIFICATIONS

P2

75

- Center drawer and Box/Tray drawers are covered in Black Duraleather that adds a prestigious touch.

Available: - Jamestown

DRAWER OPTIONS - BOTTOM COVER

FELT BOTTOM CENTER DRAWER INSERT LINER

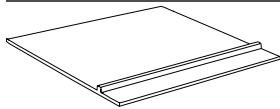

STYLE NUMBER

LIST PRICE

SPECIFICATIONS

K3

95

- Inserts into center drawer and features divider for open pen and pencil storage. Removable for easy cleaning.
- Adds a luxurious touch to center drawers.
- Color: Dark Brown Coal

Available: - All DARRAN Collections. Excludes Rail.

DRAWER OPTIONS - UPGRADE

WOOD DRAWER UPGRADE

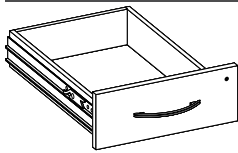

STYLE NUMBER
P33

LIST PRICE
40 Per Drawer

SPECIFICATIONS

- Dowel joint construction
- Hardwood veneer multi-ply drawer
- UV finish
- 1/4" Wood veneer bottoms
- File drawer bottoms are fiv block reinforced for heavy weight capacity
- Lifetime guaranteed

Available: - Central Park, Capitol Park, NOT SO square, Rail, Richmond Park

LIGHTING

LT-LED TASK LIGHT

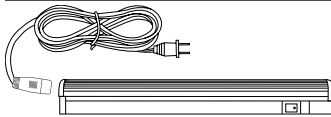

STYLE NUMBER
24" Tasklight
LT-LED24
48" Tasklight
LT-LED48
60" Tasklight
LT-LED60
Linking Cable
LC22

LIST PRICE
90
165
180
20

SPECIFICATIONS

- Anodized aluminum finish
- Tilting beam allows adjustability
- Switch with dimming control
- 50,000 hour life
- 12V power drive standard with each task light 30 watt max

Notes

- LC22: 20" LT-LED Task light linking cable

Available: - All DARRAN Collections

LIGHTING

DELETE TASK LIGHT CONCEALMENT APRON RAIL

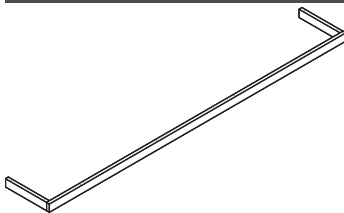

STYLE NUMBER
WAR-D

LIST PRICE
Deduct 125

SPECIFICATIONS

- Delete Tasklight Concealment apron rail when a task light is not used on a wall hung unit

Available: - Wall Hung Units

LIGHTING

SLIM LINE ALUMINUM LED TASK LIGHT

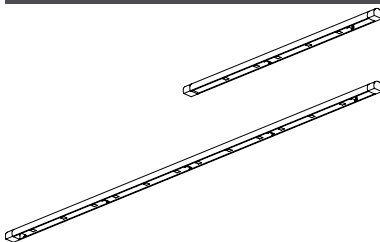

STYLE NUMBER
24" Tasklight
LED24
48" Tasklight
LED48
60" Tasklight
LED60
Linking Package
DPC

LIST PRICE
315
445
555
Deduct 85 per task light

SPECIFICATIONS

- Anodized aluminum finish
- Tilting beam allows adjustability
- Switch with dimming control
- 50,000 hour life
- 12V power drive standard with each task light 30 watt max

Notes

- Link multiple tasklights up to 30W of power wattage. Deletes 1 power drive

Available: - Rift and Spaces

LIGHTING

LED INTERIOR CABINET PUCK LIGHT

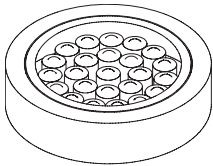

STYLE NUMBER

LIST PRICE

SPECIFICATIONS

Starter Kit
LEDPK
1 LED Interior Puck Light
PK

295

125

- Starter kit includes Infeed, 1 Puck Interior Light and the ability to daisy chain up to 6 total Puck Lights
- (1) LED Puck Light with 30W power drive and switch
- Recessed fixture
- 12V linking cord 98"L
- Silver finish
- 50,000 hour life
- 2 watt per light

Notes

- Power drive included, Light only

Available: - Overhead/Tower Units with glass doors or no doors

PEDESTAL MODIFICATIONS

BREAKFRONT PEDESTAL WITH WIRE MANAGEMENT CAVITY DOOR

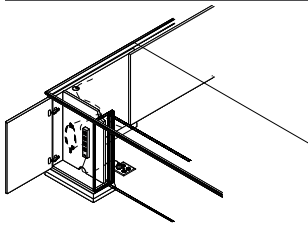

STYLE NUMBER

LIST PRICE

SPECIFICATIONS

PC10
Power Supply Cordset
PD717

95

95

- Hinged pedestal front door offers easy access for wire management
- Wire hooks provide wire coil storage
- Wire access openings allow access to floor, cabinets interior and kneespace
- Cabinet interior is black finish
- Top grommet is positioned over cavity for access ease
- (Power Strip Optional)

Notes

- Breakfront Chassis Only

Available: - All DARRAN Collections. Excludes Jamestown, Rail, Richmond, and Rift.

PEDESTAL MODIFICATIONS

BLACK LAMINATE PRINTER PULLOUT BOTTOM SHELF

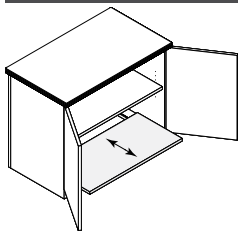

STYLE NUMBER

LIST PRICE

SPECIFICATIONS

PPOS

214

- Black Laminate pullout shelf on suspension
- Black grommet
- Adjustable Shelf

Available: - All DARRAN Collections. Excludes Rail.

PEDESTAL MODIFICATIONS

ADD VENEER KNEESPACE CABINETS - BASE

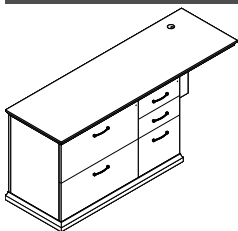

STYLE NUMBER

LIST PRICE

SPECIFICATIONS

Add Box/Box/File or File/File

P40B

985

- Multi-file specify Box/Box Left or Right

Add Lateral File 29" W

P41B

1205

Notes

- Add additional Standard Cabinets To Kneespace Area.

Add Multi-File - 31"W

P42B

1205

Add Storage With Doors 29"W

P43B

1095

Add CPU /Printer Cabinet - Open

P44B

1095

Available: - Capitol Park, Jamestown, Prado, Richmond Park

PEDESTAL MODIFICATIONS

ADD VENEER KNEESPACE CABINETS - NO BASE

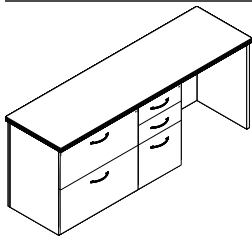

Available: - Central Park, NOT SO square

STYLE NUMBER	LIST PRICE
<i>Add Box/Box/File or File/File</i> P40W	875
<i>Add Lateral File 29" W</i> P41W	985
<i>Add Multi-File - 31"W</i> P42W	1095
<i>Add Storage With Doors 29"W</i> P43W	985
<i>Add CPU /Printer Cabinet - Open</i> P44W	985

SPECIFICATIONS
- Multi-file specify Box/Box Left or Right

Notes
- Add additional Standard Cabinets To Kneespace Area.

PEDESTAL MODIFICATIONS

ADD TECH VENEER KNEESPACE CABINETS - NO BASE

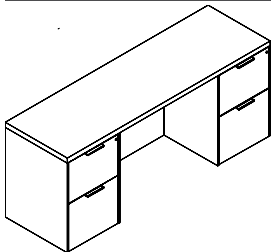

Available: - Rift

STYLE NUMBER	LIST PRICE
<i>Add Box/Box/File or File/File</i> P40T	1100
<i>Add Lateral File 29" W</i> P41T	1210
<i>Add Multi-File - 31"W</i> P42T	1320
<i>Add Storage With Doors 29"W</i> P43T	1210
<i>Add CPU /Printer Cabinet - Open</i> P44T	1210

SPECIFICATIONS
- Multi-file specify Box/Box Left or Right

Notes
- Add additional Standard Cabinets To Kneespace Area.

PEDESTAL MODIFICATIONS

ADD MELAMINE (TFL) KNEESPACE CABINETS - NO BASE

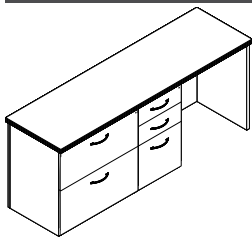

Available: - Central Park (TFL) and NOT SO square (TFL)

STYLE NUMBER	LIST PRICE
<i>Add Box/Box/File or File/File</i> P40M	688
<i>Add Lateral File 29" W</i> P41M	853
<i>Add Multi-File - 31"W</i> P42M	963
<i>Add Storage With Doors 29"W</i> P43M	765
<i>Add CPU /Printer Cabinet - Open</i> P44M	875

SPECIFICATIONS
- Multi-file specify Box/Box Left or Right

Notes
- Add additional Standard Cabinets To Kneespace Area.

PEDESTAL MODIFICATIONS

MODIFY DRAWER CONFIGURATIONS

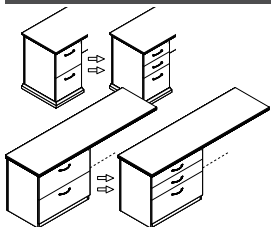

Available: - All DARRAN Collections. Excludes Rail.

STYLE NUMBER	LIST PRICE
<i>File/File to Box/Box/File</i> P6	50 per pedestal
<i>Box/Box/File to File/File</i> P6	50 per pedestal
<i>Lateral File to 2 Box Drawers</i> P8	95 per pedestal

SPECIFICATIONS
- Modify File/File To Box/Box/File - Any Unit

PEDESTAL MODIFICATIONS

MODIFY DRAWER CONFIGURATIONS

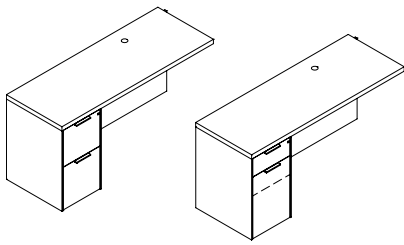

STYLE NUMBER

File/File to Box/Box/File

P6H

Lateral File to 2 Box Drawers

P8

LIST PRICE

95 per pedestal

95 per pedestal

SPECIFICATIONS

- Modify File/File To Box/Hidden Box/File - Any Unit

Available: - Rift

POWER / DATA

POWER SUPPLY CORDSET

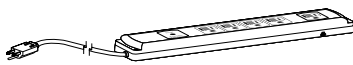

STYLE NUMBER

PD717

LIST PRICE

95

SPECIFICATIONS

- SIZE: 10.75"L x 2.0"W x 1.06"H

- (5) Outlets w/ 10' cord

- Surge suppression (720 Joules)

- 15 Amp breaker

- Available on: Vertical Panels, Cabinet Interiors, and under tops

Available: - All DARRAN Collections

PRODUCT MODIFICATIONS

MODIFY WIDTH - OPEN KNEESPACE

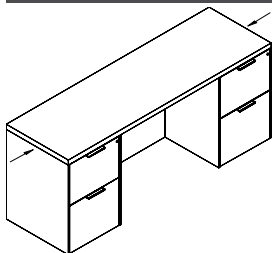

STYLE NUMBER

MOD-1

LIST PRICE

125

SPECIFICATIONS

- Modify width down on any unit with an open kneespace: desk, workstation credenza, bridge, return

Available: - All DARRAN Collections

PRODUCT MODIFICATIONS

MODIFY WIDTH - OPEN/CLOSED STORAGE

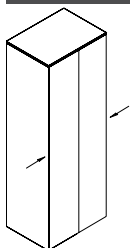

STYLE NUMBER

MOD-2

LIST PRICE

250

SPECIFICATIONS

- Modify width down on any unit with open or closed storage section: overheads, wall hung units, storage credenzas, towers

Available: - All DARRAN Collections

PRODUCT MODIFICATIONS **MODIFY WIDTH - OUTSIDE OF MOD-1, MOD-2**

STYLE NUMBER	LIST PRICE	SPECIFICATIONS
MOD-3	Contact Factory for Pricing	- Width modification outside of MOD-1 & MOD-2

Available: - All DARRAN Collections

PRODUCT MODIFICATIONS **MODIFY WIDTH - TACKBOARD, SLAT WALL, VENEER PANEL, OR A GLASSBOARD**

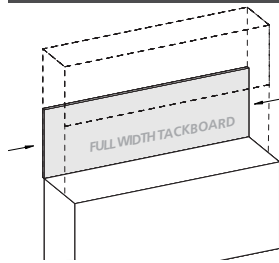

STYLE NUMBER	LIST PRICE	SPECIFICATIONS
MOD-4	50	- Modify width down on tackboard, slat wall, veneer panel, or a overhead glassboard

Available: - All DARRAN Collections

PRODUCT MODIFICATIONS **MODIFY DEPTH - DECREASE DEPTH**

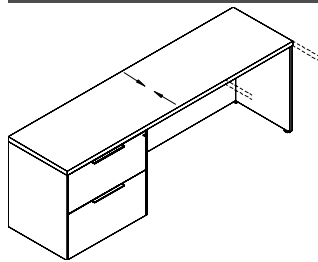

STYLE NUMBER	LIST PRICE	SPECIFICATIONS
MOD-5	125	- Modify depth down (minimum depth for a unit with drawers is 21"D)
Notes		
- Ex. 24" to 21", 30" to 24", and 36" to 30"		

Available: - All DARRAN Collections

PRODUCT MODIFICATIONS **MODIFY DEPTH - INCREASE DEPTH**

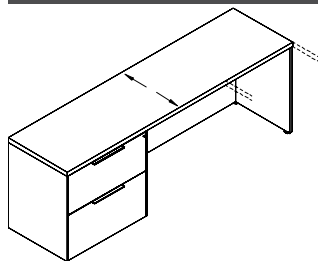

STYLE NUMBER	LIST PRICE	SPECIFICATIONS
MOD-6	Add 10%	- Increase depth
Notes		
- Ex. 24" to 30", 30" to 36", and 36" to 42"		

Available: - All DARRAN Collections. Excludes Rift.

PRODUCT MODIFICATIONS

MODIFY HEIGHT

STYLE NUMBER
MOD-7

LIST PRICE
Contact Factory
for Pricing

SPECIFICATIONS
- Modify height of a unit

Available: - All DARRAN Collections

PRODUCT MODIFICATIONS

MODIFY CONFERENCE TABLE LENGTH AND WIDTH - 1 PIECE TOP

STYLE NUMBER
MOD-8

LIST PRICE
125

SPECIFICATIONS
- Modify length/width down on a 1 piece table top

Available: - Conferencing

PRODUCT MODIFICATIONS

MODIFY CONFERENCE TABLE LENGTH AND WIDTH - 2/3 PIECE TOP

STYLE NUMBER
MOD-9

LIST PRICE
250

SPECIFICATIONS
- Modify length/width down on a 2 or 3 piece table top

Available: - Conferencing

REFRIGERATOR MODIFICATION

REFRIGERATOR CABINET MODIFICATION

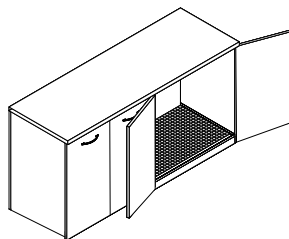

STYLE NUMBER
REF01

LIST PRICE
195

SPECIFICATIONS
- Open back cutout for venting
- Moisture sponge mat
- Contaminate ledge
- Contact customer service for maximum refrigerator size
(Changes based on unit).

Available: - Storage Credenzas

SHAPED TOPS **OVERHEAD/WALL HUNG SHAPED TOP**

STYLE NUMBER	LIST PRICE	SPECIFICATIONS
99"W - 105"W		- Shaped tops for overheads and wall hungs
TOH-1	405	
58"W - 93"W		
TOH-2	315	
29"W - 47"W		
TOH-3	203	

Available: - Central Park, Rail

SHAPED TOPS **BOOKCASE SHAPED TOP**

STYLE NUMBER	LIST PRICE	SPECIFICATIONS
29"W - 35"W x 15"D		- 15" D Shaped tops for bookcases
TOH-4	203	- Shaped on front

Available: - Central Park, Rail

SHAPED TOPS **TOWER SHAPED TOP**

STYLE NUMBER	LIST PRICE	SPECIFICATIONS
16" Single Width Tower		- 24" deep shaped tops for towers
TOH-5	158	- Shaped on front
29"W - 46"W Tower		
TOH-6	203	

Available: - Central Park, Rail

SHAPED TOPS **WORKSURFACE SHAPED TOP**

STYLE NUMBER	LIST PRICE	SPECIFICATIONS
Shape Four Sides		- S4S Applies to desk, bridge or any freestanding unit. This adds shapes or copes to two sides (desk, bridges) or one side and back of units (returns).
S4S	50	
Shape Three Sides		- S3S Applies to credenza units. This adds shapes to the two sides.
S3S	50	- Credenzas are shaped front standard with flat back
		Notes
		- Desk, Freestanding and Credenza units will grow 1" in width due to adding shapes on ends of units.

Available: - Central Park

SHAPED TOPS

PREMIUM EDGE - SHAPED WORKSURFACE TOP

STYLE NUMBER	LIST PRICE	SPECIFICATIONS
<i>Shape Four Sides Premium Edge</i>		
S4S-PE	Add 10%	- S4S-PE Applies to desk, bridge or any freestanding unit. This adds shapes or copes to two sides (desk, bridges) or one side and back with hardwood rims (returns).
<i>Shape Three Sides Premium Edge</i>		
S3S-PE	Add 10%	- S3S-PE Shape Three Sides Premium Edge. Applies to credenza units. This adds shape to the two sides with hardwood rims.
Notes		
- Desk, Freestanding and Credenza units will grow 1" in width due to adding shapes on ends of units.		

* 10% Upcharge includes 5% for premium edge

Available: - Central Park

SHELF MODIFICATIONS

GLASS SHELVES - TEMPERED FULL WIDTH 26" - 35"

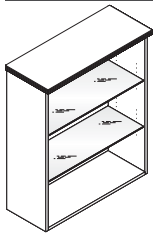

STYLE NUMBER	LIST PRICE	SPECIFICATIONS
<i>26"W - 35"W x 14"D Shelf</i>		
GS14F	85	- Glass Shelves Replace Wood Shelf In Open Or Glass Door Cabinet. Also Order Interior Cabinet Lighting.

Available: - All DARRAN Collections

SHELF MODIFICATIONS

TEMPERED GLASS SHELVES FOR HALF CABINET 17- 1/2" WIDTHS

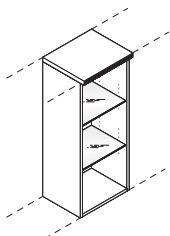

STYLE NUMBER	LIST PRICE	SPECIFICATIONS
<i>14-1/2"W - 17- 1/2"W x 14"D Shelf</i>		
GS14H	65 ea	- Glass Shelves Replace Wood Shelf In Open Or Glass Door Cabinet. Also Order Interior Cabinet Lighting.

Notes
- Replace only adjustable shelves between cabinet light and fixed lower wood shelf.

Available: - All DARRAN Collections

SHELF MODIFICATIONS

CURVED CORNER GLASS SHELF

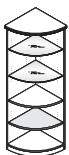

STYLE NUMBER	LIST PRICE	SPECIFICATIONS
GS14CC	85 ea	- Curved shelves feature glass retainer clips to prevent tipping

Notes
- Replace only adjustable shelves between cabinet light and fixed lower wood shelf.

Available: - All DARRAN Collections. Excludes Rail.

SHELF MODIFICATIONS

HEAVY DUTY SOLID WOOD BOOKCASE REPLACEMENT SHELVES

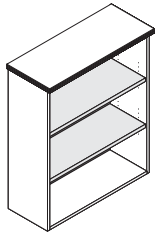

STYLE NUMBER
1" Wood Shelf 14" Deep
 S714F
1" Wood Shelf 24" Deep
 S714FX

LIST PRICE
 75 ea
 150 each

SPECIFICATIONS
 - 1" Solid Lumber Core Shelves Replace Standard 3/4" Plywood
 Adjustable And Fixed Shelves

Available: - All DARRAN Collections. Excludes Rail.

SLAT WALL ACCESSORIES

SLAT WALL ACCESSORY TRAY

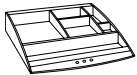

STYLE NUMBER
 SWA9

LIST PRICE
 45

SPECIFICATIONS
 - Specify Black Or Matte Silver

Available: - All DARRAN Collections. Excludes Rail.

SLAT WALL ACCESSORIES

SLAT WALL FOLDER TRAY



STYLE NUMBER
 SWA7

LIST PRICE
 45

SPECIFICATIONS
 - Specify Black Or Matte Silver

Available: - All DARRAN Collections. Excludes Rail.

SLAT WALL ACCESSORIES

SLAT WALL PAPER TRAY



STYLE NUMBER
 SWA2

LIST PRICE
 35

SPECIFICATIONS
 - Specify Black Or Matte Silver

Available: - All DARRAN Collections. Excludes Rail.

SLAT WALL ACCESSORIES

SLAT WALL PENCIL HOLDER



STYLE NUMBER
SWA4

LIST PRICE
25

SPECIFICATIONS
- Specify Black Or Matte Silver

Available: - All DARRAN Collections. Excludes Rail.

SPECIALTY VENEER ACCENTS

BLACK EBONY WOOD INLAY IN ONE PIECE CONFERENCE TOP

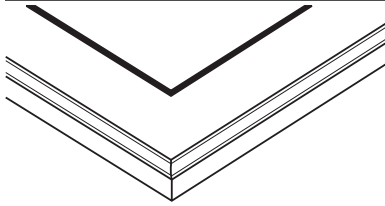

STYLE NUMBER
One Piece Conference Top
T30
Two Piece Conference Top
T31

LIST PRICE
735
1480

SPECIFICATIONS
- Standard veneer top is routed for Ebony wood inlay 1/8" x 3/16" width line. Inlay wood is miter jointed in the corners, hand fitted, glued and sanded flush with top veneer. Inlay forms a 3" border to top edge

Notes
- Hand fitted miter corner Black Ebony wood inlay installed in standard wood veneer tops

Available: - Conferencing Tops.

SPECIALTY VENEER ACCENTS

BLACK/WHITE/BLACK WOOD INLAY

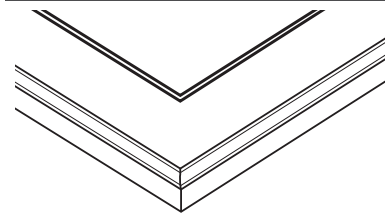

STYLE NUMBER
One Piece Top
T30BWB
Two Piece Top
T31BWB

LIST PRICE
950
1795

SPECIFICATIONS
- Standard veneer top is routed for wood inlay 1/8" x 3/16" width line. Each color is 1/16" wide. White inlay line is finished over providing a subtle contrast to line detail

Notes
- Hand fitted miter corner ebony-maple-ebony wood inlay installed in standard veneer top
- The center white line can be masked off preventing color stains from penetrating. Final top coats are applied over the white line.

Available: - Conferencing Tops

SPECIALTY VENEER ACCENTS

BLACK EBONY WOOD INLAY W/ WOOD FAN DETAIL - 1 PIECE CONFERENCE TABLE TOP

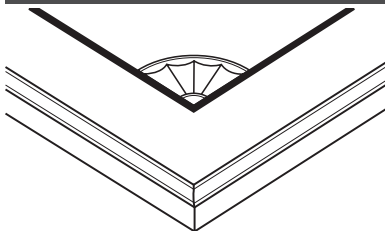

STYLE NUMBER
One Piece Top
T51
Two Piece Top
T52

LIST PRICE
1160
2110

SPECIFICATIONS
- Standard veneer top is routed for wood inlay 1/8" x 3/16" width line. With each 90 degree corner routed for Quarter circle fan inlays. Inlay fans combined with solid black inlay preserves an old traditional appearance. Fans are handcrafted from teakwood, rosewood, mahogany, and other exotic woods. Each piece of veneer is shaded by burning and is hand fitted to a perfect fan shape - truly and old world craft
- Conference tables: 4 fans, one in each corner per top section

Notes
- Hand fitted miter corner wood inlay and fan installed in standard veneer top
- Only available on square/ rectangle tops

Available: - Conferencing Tops

SPECIALTY VENEER ACCENTS

CROTCH MAHOGANY INFIELD WITH MITERED BORDER



STYLE NUMBER

- TCB-1 - 84 x 36/42
- TCB-2 - 72 x 36/42
- TCB-3 - 72 x 30/36

LIST PRICE

- 1895
- 1795
- 1695

SPECIFICATIONS

- Center balanced butt and book matched crotch mahogany
- 35 sheen non-rubbed finish ensures maximum durability

Available: - Jamestown, Prado

SPECIALTY VENEER ACCENTS

CROTCH MAHOGANY DESK PEDESTAL FRONTS

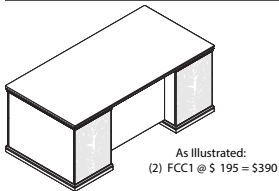

Desk Approach
Pedestal Fronts

STYLE NUMBER

FCC1

LIST PRICE

195 per pedestal

SPECIFICATIONS

- Center balanced butt and book matched crotch mahogany
- 35 sheen non-rubbed finish ensures maximum durability

Available: - Jamestown, Prado

SPECIALTY VENEER ACCENTS

CROTCH MAHOGANY DRAWER FRONTS

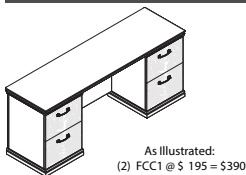

Box/Box/File or File/File
Drawer Fronts

STYLE NUMBER

FCC1

LIST PRICE

195 per pedestal

SPECIFICATIONS

- Center balanced butt and book matched crotch mahogany
- 35 sheen non-rubbed finish ensures maximum durability

Available: - Jamestown, Prado

SPECIALTY VENEER ACCENTS

CROTCH MAHOGANY DOUBLE WIDTH PANEL FRONTS



All Three Illustrations Represent: (1) FCC2 @ \$395

30-32-36 Width
FCC-2 \$395 per Panel Set

STYLE NUMBER

FCC2

LIST PRICE

395 per Panel Set

SPECIFICATIONS

- Center balanced butt and book matched crotch mahogany
- 35 sheen non-rubbed finish ensures maximum durability

Available: - Jamestown, Prado

SPECIALTY VENEER ACCENTS

CROTCH MAHOGANY DOUBLE WIDTH/ DOUBLE HEIGHT FRONTS



STYLE NUMBER
FCC3

LIST PRICE 895 per Panel Set
SPECIFICATIONS
 - Center balanced butt and book matched crotch mahogany
 - 35 sheen non-rubbed finish ensures maximum durability

Both Illustrations Represent:
 (1) FCC3 @ \$895 - Panel Set
 30-36 Width
 FCC-3 \$895 per Panel Set
 52" Center Balance Butt & Bookmatch

Available: - Jamestown, Prado

SPECIALTY VENEER ACCENTS

RECTANGLE INLAY - RECESSES DURA-LEATHER WRITING SURFACE



RECTANGLE INLAY

STYLE NUMBER
RL-29A

LIST PRICE 895
SPECIFICATIONS
 - Recessed inlay desk pads are covered with Alomost Leather from Paul Brayton Designs.
 - DARRAN will gladly custom quote other inlay materials ie: solid surfaces, biocomposites, metallic laminates, or genuine leather to match seating

Available: - All DARRAN Collections

SPECIALTY VENEER ACCENTS

BOWFRONT INLAY - RECESSES DURA-LEATHER WRITING SURFACE

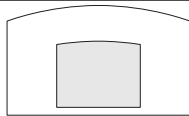

BOWFRONT INLAY

STYLE NUMBER
RL-31A

LIST PRICE 995
SPECIFICATIONS
 - Recessed inlay desk pads are covered with Alomost Leather from Paul Brayton Designs.
 - DARRAN will gladly custom quote other inlay materials ie: solid surfaces, biocomposites, metallic laminates, or genuine leather to match seating

Available: - All DARRAN Collections

SPECIALTY VENEER ACCENTS

RECTANGLE INLAY - EBONY HARDWOOD INLAY DETAIL

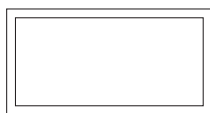

RECTANGLE INLAY

STYLE NUMBER
T10SA

LIST PRICE 895
SPECIFICATIONS
 - 3/16" x 3/16" thick hardwood ebony inlay is handfitted and glued into routed top and sanded flush with surface
 - Inlay is finished over with all finish steps

Notes
 - Ebony inlay not recommended in: Koko Cherry

Available: - All DARRAN Collections

SPECIALTY VENEER ACCENTS

BOWFRONT INLAY - EBONY HARDWOOD INLAY DETAIL

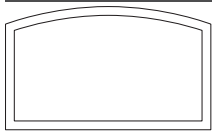

CURVED INLAY

STYLE NUMBER
T11SA

LIST PRICE
995

SPECIFICATIONS
- 3/16" x 3/16" thick hardwood ebony inlay is handfitted and glued into routed top and sanded flush with surface
- Inlay is finished over with all finish steps

Notes
- Ebony inlay not recommended in: Koko Cherry

Available: - All DARRAN Collections

TOOL CHANNEL ACCESSORIES

RECESSED ALUMINUM TOOL CHANNEL

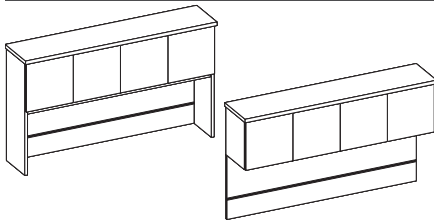

STYLE NUMBER
ATB02

LIST PRICE
5 per 1"W

SPECIFICATIONS
- Anodized aluminum finish
- Fully recessed
- Finish matches anodized aluminum accessories
- Can be specified with fabric tack surface mounted above channel

Notes
- If using tool channel with wallhung overhead, a veneer panel must be specified.

Available: - All DARRAN Collections. Excludes Rail.

TOOL CHANNEL ACCESSORIES

FILE HOLDER

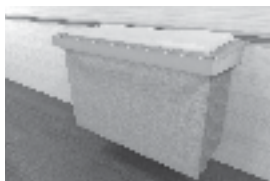

STYLE NUMBER
ATB37

LIST PRICE
105

SPECIFICATIONS
- For Console/Wall Hung Back Panels With Optional Tool Bar
- 18 Gauge Steel - Stamp Formed
- Silver Powderdercoat Finish

Available: - All DARRAN Collections. Excludes Rail.

TOOL CHANNEL ACCESSORIES

IPHONE HOLDER



STYLE NUMBER
ATB31

LIST PRICE
120

SPECIFICATIONS
- For Console/Wall Hung Back Panels With Optional Tool Bar
- 18 Gauge Steel - Stamp Formed
- Silver Powderdercoat Finish
- 5" x 3 -3/4"W
- Non-slip Neoprene pad

Available: - All DARRAN Collections. Excludes Rail.

TOOL CHANNEL ACCESSORIES

LARGE SHELF

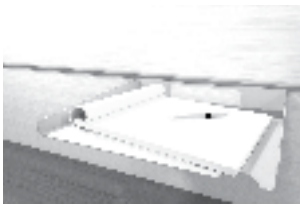

STYLE NUMBER
ATB35

LIST PRICE
125

SPECIFICATIONS
- 12"W x 10"D

Available: - All DARRAN Collections. Excludes Rail.

TOOL CHANNEL ACCESSORIES

PENCIL PEN HOLDER

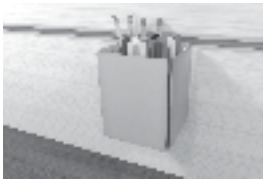

STYLE NUMBER
ATB38

LIST PRICE
115

SPECIFICATIONS
- For Console/Wall Hung Back Panels With Optional Tool Bar
- 18 Gauge Steel - Stamp Formed
- Silver Powdercoat Finish
- 5"H x 4"W x 4"D

Available: - All DARRAN Collections. Excludes Rail.

TOOL CHANNEL ACCESSORIES

SMALL SHELF



STYLE NUMBER
ATB36

LIST PRICE
110

SPECIFICATIONS
- 12"W x 6 -3/4"D

Available: - All DARRAN Collections. Excludes Rail.

TOOL CHANNEL ACCESSORIES

TABLET HOLDER

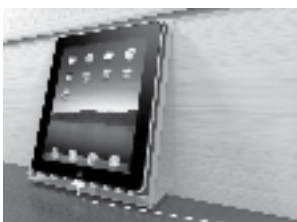

STYLE NUMBER
ATB30

LIST PRICE
135

SPECIFICATIONS
- For Console/Wall Hung Back Panels With Optional Tool Bar
- 18 Gauge Steel - Stamp Formed
- Silver Powdercoat Finish
- 10" x 8"W
- Non-slip Neoprene pad

Available: - All DARRAN Collections. Excludes Rail.

TOP MODIFICATION

1/4" RECTANGLE SOFT ETCH GLASS RUNOFF WORKSURFACE

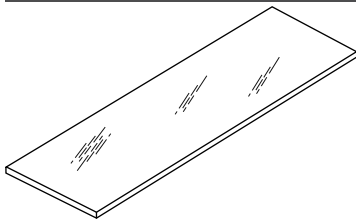

STYLE NUMBER

SEGW8436
 SEGW8430
 SEGW7836
 SEGW7830
 SEGW7230
 SEGW6630
 SEGW6030

LIST PRICE

2210
 1870
 2070
 1750
 1630
 1515
 1395

SPECIFICATIONS

- 1/4" Soft etch glass
- Back painted white glass

Notes

- Additional colors can be custom quoted. Contact factory for pricing.

Available: - Rift Runoff Worksurface

TOP MODIFICATION

TOP APRON RAIL

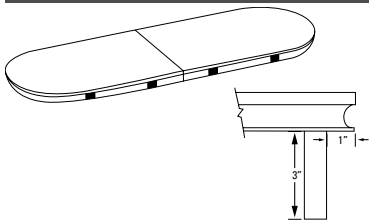

STYLE NUMBER

TAR

LIST PRICE

Add 10% to top price for apron only

SPECIFICATIONS

- 3 x 3/4 thick apron rail is set back under top 1"
- Apron rail is recommended for fixed port installation for power/data support.

Notes

- Select power/data support separately.
- See power options for available apron power: UDT2/VD-SM

Available: - Conferencing Tops Only

TOP MODIFICATION

TOP APRON RAIL

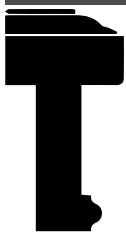

STYLE NUMBER

TAR-M

LIST PRICE

Add 15% (Apron rail with beltline detail)

SPECIFICATIONS

- Traditional with apron rail and molding - available in Cherry and Walnut.

Notes

- Select power/data support separately.
- See power options for available apron power: UDT2/VD-SM

Available: - Conference tops only

WIRE MANAGEMENT

HORIZONTAL J-CHANNEL WIRE MANAGEMENT RACEWAY

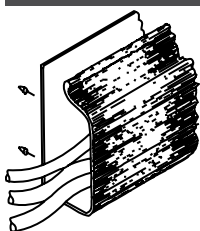

STYLE NUMBER

W1

LIST PRICE

75 Per 4 Foot Section

SPECIFICATIONS

- 4' section for field installation.
- The "J" shape black thermoplastic wire raceway may be added to specified worksurface tops to provide concealed channeling of wires to and from worksurface grommets. For use in open kneespace areas, raceway is attachable to top of back panel with pan head screws. Interior dimensions are 1" x 1- 1/2" providing ample storage for multiple wires and excess cable. Front of raceway flexes out for easy cord insertion.

Notes

- Units w/ Wire Channel Standard.
- Field Installation

Available: - All DARRAN Collections.

WIRE MANAGEMENT

HORIZONTAL U-CHANNEL WIRE MANAGEMENT RACEWAY



STYLE NUMBER
W2A

LIST PRICE
75 Per 4 Foot Section

SPECIFICATIONS
- 4' section for field installation.

Notes
- Units w/ Wire Channel Standard.
- Field Installation

Available: - All DARRAN Collections.

WIRE MANAGEMENT

COIL WIRE MANAGER



STYLE NUMBER
W18

LIST PRICE
150

SPECIFICATIONS
- Weighted Base, Table attachment plate
- 39- 1/2" Length
- Black

Notes
- Location

Available: - All DARRAN Collections.

WIRE MANAGEMENT

STANDARD LOCATION GROMMETS - FACTORY INSTALLED

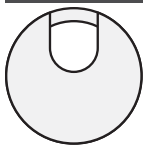

STYLE NUMBER
Standard Location Grommet

Black
TM30

Silver
TM31

Antique Brass
TM33

White
TM34

LIST PRICE

45

45

45

45

45

SPECIFICATIONS
- 1 -5/8" Metal Grommet

Notes
- *Units w/ Grommets Standard Are Noted Under Standard Features. Grommets Match Pull Finish - Standard (Unless Specified Otherwise)

Available: - All DARRAN Collections.

WIRE MANAGEMENT

NON-STANDARD LOCATION GROMMETS - FACTORY INSTALLED

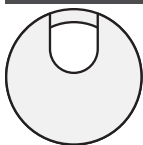

STYLE NUMBER
Non-Standard Location Grommet

Black
TM30 -NS

Silver
TM31 -NS

Antique Brass
TM33 -NS

White
TM34 -NS

LIST PRICE

90

90

90

90

90

SPECIFICATIONS
- 1 -5/8" Metal Grommet

Notes
- *Units w/ Grommets Standard Are Noted Under Standard Features. Grommets Match Pull Finish - Standard (Unless Specified Otherwise)

Available: - All DARRAN Collections

WIRE MANAGEMENT

BLACK PLASTIC VERTICAL SURFACE GROMMETS - FACTORY INSTALLED



STYLE NUMBER	LIST PRICE	SPECIFICATIONS
<i>Standard Location Grommet</i>		- 2 " Black Plastic Grommet
TM50-C	45	Notes - Standard Location is Bottom Center
<i>Non-Standard Location Grommet</i>		
TM50-NS	90	

Available: - All DARRAN Collections

WORKSTATION

CLIENT PULLOUT WRITING SHELF

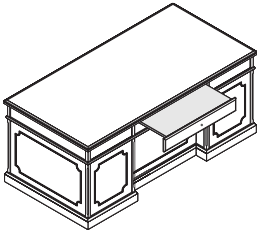

STYLE NUMBER	LIST PRICE	SPECIFICATIONS
CP-1	425	- CP-1: Client pull-out writing shelf for executive chassis desk
CP-2	625	- CP-2: Client pull-out writing shelf for conference desk

Available: - Jamestown

AIRCHARGE WIRELESS CHARGING GROMMET

STYLE NUMBER	LIST PRICE
ACWG WIRELESS GROMMET	\$575
ACWR WIRELESS RECEIVER W/ LIGHTNING CABLE	\$170



SPECIFICATIONS

- AirCharge offers a convenient way to charge any Qi compatible smartphone or device without the need to carry charging cables or find an available power outlet. Devices not equipped with the Qi technology, can be adapted to accept a charge from the grommet with the AirCharge Wireless Receiver.
- Size: 3.33" DIA x .75"D
- Compatible with an Qi rated device, Contact Customer Service for compatibility list
- Non-Qi device can be adapted to accept AirCharge unit with an ACWR AirCharge Wireless Receiver (compatible with iPhone)
- Surface Mount
- 78" Cord
- Standard Black Aluminum Finish; Available in White Aluminum or Black Finish upon request

AVAILABLE

- All Darran Collections

AirCharge Wireless Grommet



iphone w/ ACWR



Black Aluminum



Black Finish



White Aluminum

COVE POWER UNIT - NON-LINKING

STYLE NUMBER	LIST PRICE
 PD COVE PLUG Non-Linking Version	\$550

SPECIFICATIONS

- Size 5.75" L x 2.5" W
- (2) 15 Amp Receptacles and (2) USB charging ports
- Surface Mount
- 108" Cord
- Standard Silver Finish, Available in White or Black Finish upon request
- ETL Listed

AVAILABLE

- All Darran Collections



COVE POWER UNIT WITH DAISYLINK

STYLE NUMBER

LIST PRICE

STARTER UNITS



COV-DCH HARDWIRED

\$710

Includes (1) Cove unit with Hardwire Infeed - 120"

COV-DCP PLUG

\$800

Includes (1) Cove unit with Plug infeed - Includes 72" Cord and 32" Infeed Jumper for 104" total cord infeed

ADDITIONAL LINKING UNITS

COV-DCL

\$575 EACH

Includes Linking Cove unit and Jumper up to 96", cable length determined by the top size

SPECIFICATIONS

- Size: 5.75" L x 2.5" W
- (2) 15 Amp Receptacles and (2) 2.1 Amp USB charging ports
- Surface Mount
- Max Daisy Chain - Hardwire - (9) units; Plug/Corded - (4) units
- Standard Silver Finish, Available in White or Black Finish upon request
- ETL Listed

AVAILABLE

- All Darran Collections



COVE CORDED SERIES

STYLE NUMBER	LIST PRICE
PD-COVE-PKO	\$800



SPECIFICATIONS

- Size 9.5”L x 2.5”W x 3.18”D
- (2) Power Receptacles, (2) 2.1 Amp USB charging ports and (1) Telecom Plate Knockout
- Surface Mount
- 108” Cord
- Standard Silver Finish, Available in White or Black Finish upon request
- ETL Listed

AVAILABLE



- All Darran Collections

TELECOM PLATES

THIS POD CAN HAVE UP TO 1 TOTAL PLATES

STYLE NUMBER	LIST PRICE
RJ45 (1)	\$35
RJ45 (2)	\$70
RJ45 (3)	\$105
USB (1)	\$70
USB (2)	\$140
RJ11/RJ45	\$70
RJ45/USB	\$105
RJ45/HDMI	\$190
HDMI/DVI	\$325
HDMI/USB	\$205
HDMI/VGA	\$240
VGA/MINI-STEREO	\$155
VGA/USB	\$175

PDFAA FLUSH DATA BAY ANODIZED ALUMINUM DOOR

	STYLE NUMBER	LIST PRICE
	PDFAA-H Hardwired	\$1195
	PDFAA-C Plug	\$1195
	PDFAA-DC Daisy Chain	\$1395

Features convenience plug on bottom - Max Daisy chain (4) units
 - Specify hardwired or plug for the first unit in series, daisy chained units will have a plug for connection through convenience plug.

SPECIFICATIONS

- Size 13.75"L x 6.375"W x 2.85"D
- (4) 15 Amp receptacles
- Surface Mount
- Standard Interior Black Finish
- Specify up to (4) Telecom Plates; (2) on side and (2) on bottom
- Corded units are UL Listed and CSA Certified. Hardwired Units are CSA Certified



AVAILABLE



- All Darran Collections
- Excludes Rail, Grove

TELECOM PLATES

THIS POD CAN HAVE UP TO 4 TOTAL PLATES

STYLE NUMBER	LIST PRICE
RJ45 (1)	\$35
RJ45 (2)	\$70
RJ45 (3)	\$105
USB (1)	\$70
USB (2)	\$140
RJ11/RJ45	\$70
RJ45/USB	\$105
RJ45/HDMI	\$190
HDMI/DVI	\$325
HDMI/USB	\$205
HDMI/VGA	\$240
VGA/MINI-STEREO	\$155
VGA/USB	\$175

PDFAF FLUSH DATA BAY FROSTED GLASS DOOR WITH DAISYLINK

STYLE NUMBER	LIST PRICE
 PDFAF-H HARDWIRED	\$1095
 PDFAF-C PLUG	\$1095
 PDFAF-DC DAISY CHAIN	\$1295

Features convenience plug on bottom - Max Daisy chain (4) units
 - Specify hardwired or plug for the first unit in series, daisy chained units will have a plug for connection through convenience plug.



SPECIFICATIONS

- Size 13.75”L x 6.375”W x 2.85”D
- (4) 15 Amp receptacles
- Surface Mount
- Standard Interior Black Finish
- Specify up to (4) Telecom Plates; (2) on side and (2) on bottom
- Corded units are UL Listed and CSA Certified. Hardwired Units are CSA Certified

AVAILABLE

- All Darran Collections
- Excludes Rail, Grove



TELECOM PLATES

THIS POD CAN HAVE UP TO 4 TOTAL PLATES

STYLE NUMBER	LIST PRICE
RJ45 (1)	\$35
RJ45 (2)	\$70
RJ45 (3)	\$105
USB (1)	\$70
USB (2)	\$140
RJ11/RJ45	\$70
RJ45/USB	\$105
RJ45/HDMI	\$190
HDMI/DVI	\$325
HDMI/USB	\$205
HDMI/VGA	\$240
VGA/MINI-STEREO	\$155
VGA/USB	\$175

REEF POWER UNIT WITH DAISYLINK

STYLE NUMBER

LIST PRICE



REF310 PLUG

\$1100

SPECIFICATIONS

- Size 16.1”L x 6.25”W x 4.89”D
- (3) 120V Receptacles, (2) USB charging ports and (2) Knockouts for RJ45 Data Ports
- Surface Mount
- 108” Cord
- Features Convenience Plug on bottom of unit that allows for max (3) Daisy Chain
- Standard Black Finish, Available in White or Silver Finish upon request
- Additional Telecom Plate Knockout
- When used with Grove Tables an additional \$350 LIST will apply for the special cutout required.
- RJ45 for Knockouts not required. If not ordered a small hole will be present in the pod in this this location
- ETL Listed

AVAILABLE

- Grove
- Conferencing



TELECOM PLATES

THIS POD CAN HAVE UP TO 1 TOTAL PLATES

STYLE NUMBER	LIST PRICE
RJ45 (1)	\$35
RJ45 (2)	\$70
RJ45 (3)	\$105
USB (1)	\$70
USB (2)	\$140
RJ11/RJ45	\$70
RJ45/USB	\$105
RJ45/HDMI	\$190
HDMI/DVI	\$325
HDMI/USB	\$205
HDMI/VGA	\$240
VGA/MINI-STEREO	\$155
VGA/USB	\$175



SECLUSION CORDED POWER UNIT NON-LINKING

STYLE NUMBER

LIST PRICE



P2SECL

\$245

Choose from plate mount or clamp mount (seen in photo)

SPECIFICATIONS

- Size: 3.5"L x 2.2"D x 2.5"H
- (2) Power Receptacles
- Worksurface Clamp Mount or Plate Under Surface Mount
- Clamp Accessory accommodates table thickness up to 2"
- 72" Cord
- Standard Silver Finish, Black Finish available upon request
- UL/UCL Listed

AVAILABLE

- All Darran Collections



Clamp Mount

UDT POWER UNIT - NON-LINKING

STYLE NUMBER	LIST PRICE
 UDT2/VD-SM PLUG Non-Linking	\$350



SPECIFICATIONS

- Size 6.5"L x 2.81"D x 1.26"H
- (2) Power receptacles and (1) Telecom Plate Cutout
- Side Mount, if Top Mount is required contact customer service
- 72" Cord
- Standard Black Powdercoat Finish
- Used in Apron Rails
- UL Listed

AVAILABLE

- Conferencing Apron Rails

TELECOM PLATES

THIS POD CAN HAVE UP TO 1 TOTAL PLATES

STYLE NUMBER	LIST PRICE
RJ45 (1)	\$35
RJ45 (2)	\$70
RJ45 (3)	\$105
USB (1)	\$70
USB (2)	\$140
RJ11/RJ45	\$70
RJ45/USB	\$105
RJ45/HDMI	\$190
HDMI/DVI	\$325
HDMI/USB	\$205
HDMI/VGA	\$240
VGA/MINI-STEREO	\$155
VGA/USB	\$175

VILLA POWER UNIT - NON-LINKING

STYLE NUMBER	LIST PRICE
 VIL-C PLUG Non-Linking	\$515

SPECIFICATIONS

- Size: Top Grommet 5.68"L X 3.39"W; Under Top 12"L x 3.13"W x 3.08"D
- (2) Power receptacles; (2) USB charging ports and (1) Knockouts for RJ45 Data Ports
- Surface Mount
- 72" Cord (Longer cord available, contact Customer Service)
- Standard Silver Finish, Black Finish available upon request
- UL or ETL Certified

AVAILABLE

- All Darran Collections
- Excludes Grove

RJ45 KNOCKOUT

STYLE NUMBER	LIST PRICE
RJ45 (1)	\$35



VILLA POWER UNIT WITH DAISYLINK

STYLE NUMBER LIST PRICE

STARTER UNITS



VIL-DCH HARDWIRED \$600
Includes (1) Villa unit with 120" Hardwire Infeed



VIL-DCP PLUG \$695
Includes (1) Villa with Plug Infeed - Includes 72" Cord and 32" Infeed Jumper for 104" total cord infeed

ADDITIONAL LINKING UNITS

VIL-DCL ADDITIONAL \$590
(Includes linking Villa and Jumper cable up to 96")



SPECIFICATIONS

- Size: Top Grommet 5.68" L X 3.39"W; Under Top 12"L x 3.13"W x 3.08"D
- (4) Power receptacles; (2) surface and (2) undersurface, (2) 2.1A USB charging ports and (1) Knockout for RJ45 Data Port
- Surface Mount
- Daisy Chain - Hardwire Max (10) Units, Plug/Corded Max (5) Units
- Standard Silver Finish, Black Finish available upon request
- UL or ETL Certified

AVAILABLE

- All Darran Collections
- Excludes Grove



RJ45 KNOCKOUT

STYLE NUMBER	LIST PRICE
RJ45 (1)	\$35